

KENWOOD

AUDIO-VIDEO CONTROL CENTER

KRF-V9300D

KRF-V8300D

KRF-V7300D

INSTRUCTION MANUAL

Kenwood Corporation



**Declaration of Conformity with regard to
the EMC Directive 2004/108/EC**

Manufacturer:

Kenwood Corporation
2967-3 Ishikawa-machi, Hachioji-shi, Tokyo, 192-8525 Japan

EU Representative's:

Kenwood Electronics Europe BV
Amsterdamseweg 37, 1422 AC UITHOORN, The Netherlands



HDMI



Auto Room EQ

RDS

Safety precautions

⚠ Caution : Read this page carefully to ensure safe operation.

Units are designed for operation as follows.

Australia AC 240 V only
 Europe AC 230 V only

WARNING :

TO PREVENT FIRE OR ELECTRIC SHOCK, DO NOT EXPOSE THIS APPLIANCE TO RAIN OR MOISTURE.



CAUTION
 RISK OF ELECTRIC SHOCK
 DO NOT OPEN



CAUTION: TO REDUCE THE RISK OF ELECTRIC SHOCK, DO NOT REMOVE COVER (OR BACK). NO USER-SERVICEABLE PARTS INSIDE. REFER SERVICING TO QUALIFIED SERVICE PERSONNEL.



THE LIGHTNING FLASH WITH ARROWHEAD SYMBOL, WITHIN AN EQUILATERAL TRIANGLE, IS INTENDED TO ALERT THE USER TO THE PRESENCE OF UNINSULATED "DANGEROUS VOLTAGE" WITHIN THE PRODUCT'S ENCLOSURE THAT MAY BE OF SUFFICIENT MAGNITUDE TO CONSTITUTE A RISK OF ELECTRIC SHOCK TO PERSONS.



THE EXCLAMATION POINT WITHIN AN EQUILATERAL TRIANGLE IS INTENDED TO ALERT THE USER TO THE PRESENCE OF IMPORTANT OPERATING AND MAINTENANCE (SERVICING) INSTRUCTIONS IN THE LITERATURE ACCOMPANYING THE APPLIANCE.

Information on Disposal of Old Electrical and Electronic Equipment and Batteries (applicable for EU countries that have adopted separate waste collection systems)



Products and batteries with the symbol (crossed-out wheeled bin) cannot be disposed as household waste.

Old electrical and electronic equipment and batteries should be recycled at a facility capable of handling these items and their waste byproducts.



Contact your local authority for details in locating a recycle facility nearest to you. Proper recycling and waste disposal will help conserve resources whilst preventing detrimental effects on our health and the environment.

Pb

Notice: The sign "Pb" below the symbol for batteries indicates that this battery contains lead.

Unpacking

Unpack the unit carefully and make sure that all the accessories are present.

FM indoor antenna (1)

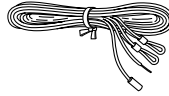

AM loop antenna (1)

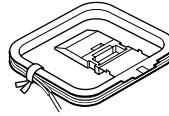

Remote control unit (1)

- KRF-V9300D : RC-R0923
- KRF-V8300D : RC-R0831
- KRF-V7300D : RC-R0733

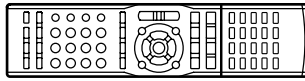

Batteries* (R03) (2)

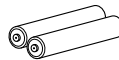

* Batteries are attached to the packing material.

KRF-V9300D/KRF-V8300D only

Setup microphone (Cord length : About 5m) (1)



If any accessories are missing, or if the unit is damaged or fails to operate, notify your dealer immediately. If the unit was shipped to you directly, notify your shipper immediately. Kenwood recommends that you retain the original carton and packing materials in case you need to move or ship the unit in the future.

Keep this manual handy for future reference.

IMPORTANT SAFETY INSTRUCTIONS

⚠ Caution :Read this page carefully to ensure safe operation.

Read Instructions – All the safety and operating instructions should be read before the product is operated.

Retain Instructions – The safety and operating instructions should be retained for future reference.

Heed Warnings – All warnings on the product and in the operating instructions should be adhered to.

Follow Instructions – All operating and use instructions should be followed.

1. Cleaning – Unplug this product from the wall outlet before cleaning. Do not use liquid cleaners or aerosol cleaners. Use a damp cloth for cleaning.

2. Attachments – Do not use attachments not recommended by the product manufacturer as they may cause hazards.

3. Water and Moisture – This product shall not be exposed to dripping and splashing – for example, near a bath tub, wash bowl, kitchen sink, or laundry tub; in a wet basement; or near a swimming pool; and the like. Do not place an object containing liquid, such as a flower vase, on the appliance.

4. Accessories – Do not place this product on an unstable cart, stand, tripod, bracket, or table. The product may fall, causing serious injury to a child or adult, and serious damage to the product. Use only with a cart, stand, tripod, bracket, or table recommended by the manufacturer. Any mounting of the product should follow the manufacturer's instructions, and should use a mounting accessory recommended by the manufacturer. A product and cart combination should be moved with care. Quick stops, excessive force, and uneven surfaces may cause the product and cart combination to overturn.



5. Ventilation – Slots and openings in the cabinet are provided for ventilation and to ensure reliable operation of the product and to protect it from overheating, and these openings must not be blocked or covered. The openings should never be blocked by placing the product on a bed, sofa, rug, or other similar surface. This product should not be placed in a built-in installation such as a bookcase or rack unless proper ventilation is provided or the manufacturer's instructions have been adhered to.

6. Power Sources – This product should be operated only from the type of power source indicated on the product. If you are not sure of the type of power supply to your home, consult your product dealer or local power company.

7. CAUTION – Polarization – This product may be equipped with a polarized alternating-current line plug (a plug having one blade wider than the other). This plug will fit into the power outlet only one way. This is a safety feature. If you are unable to insert the plug fully into the outlet, try reversing the plug. If the plug should still fail to fit, contact your electrician to replace your obsolete outlet. Do not defeat the safety purpose of the polarized plug.

8. Power Cord Protection – Power-supply cords should be routed so that they are not likely to be walked on or pinched by items placed upon or against them, paying particular attention to cords at plugs, convenience receptacles, and the point where they exit from the product.

9. Lightning – For added protection for this product during a lightning storm, or when it is left unattended and unused for long periods of time, unplug it from the wall outlet and disconnect the antenna or cable system. This will prevent damage to the product due to lightning and power-line surges.

10. Overloading – Do not overload wall outlets, extension cords, or integral convenience receptacles as this can result in a risk of fire or electric shock.

11. Object and Liquid Entry – Never push objects of any kind into this product through openings as they may touch dangerous voltage points or short-out parts that could result in a fire or electric shock. Never spill liquid of any kind on the product.

12. Servicing – Do not attempt to service this product yourself as opening or removing covers may expose you to dangerous voltage or other hazards. Refer all servicing to qualified service personnel.

13. Damage Requiring Service – Unplug this product from the wall outlet and refer servicing to qualified service personnel under the following conditions:

- a) When the power-supply cord or plug is damaged,
- b) If liquid has been spilled, or objects have fallen into the product,
- c) If the product has been exposed to rain or water,
- d) If the product does not operate normally by following the operating instructions.
- e) If the product has been dropped or damaged in any way, and
- f) When the product exhibits a distinct change in performance – this indicates a need for service.
- g) If an abnormal smell or smoke is detected.

14. Replacement Parts – When replacement parts are required, be sure the service technician has used replacement parts specified by the manufacturer or have the same characteristics as the original part. Unauthorized substitutions may result in fire, electric shock, or other hazards.

15. Safety Check – Upon completion of any service or repairs to this product, ask the service technician to perform safety checks to determine that the product is in proper operating condition.

16. Wall or Ceiling Mounting – This product should be mounted to a wall or ceiling only as recommended by the manufacturer.

17. Heat – This product should be situated away from heat sources such as radiators, heat registers, stoves, or other products that produce heat. Do not place a flaming object, such as a candle or lantern, or near the product.

18. Power Lines – An outside antenna system should not be located in the vicinity of overhead power lines or other electric light or power circuits, or where it can fall into such power lines or circuits. When installing an outside antenna system, extreme care should be taken to keep from touching such power lines or circuits as contact with them might be fatal.

19. Outdoor Antenna Grounding – If an outside antenna or cable system is connected to the product, be sure the antenna or cable system is grounded so as to provide some protection against voltage surges and built-up static charges. Article 810 of the National Electrical Code, ANSI/NFPA 70, provides information with regard to proper grounding of the mast and supporting structure, grounding of the lead-in wire to an antenna discharge unit, size of grounding conductors, location of antenna-discharge unit, connection to grounding electrodes, and requirements for the grounding electrode.

EXAMPLE OF ANTENNA GROUNDING AS PER NATIONAL ELECTRICAL CODE

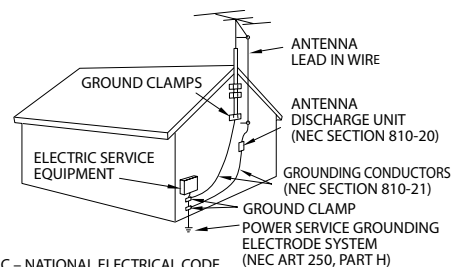

Notes:

- 1. Item 7 is not required except for grounded or polarized equipment.
- 2. Item 19 complies with UL in the U.S.A.

Before use

Contents

⚠ To ensure safety, read the items carrying this marking carefully.

Before use

Before use

⚠ Safety precautions	2
Unpacking	2
⚠ IMPORTANT SAFETY INSTRUCTIONS	3
Special Features	5
How to read this manual.....	6
iPod models usable with this unit.....	7
Names and functions of parts	8

Connections 14 – 29

Setup

Setup menu and its operations.....	30
KRF-V7300D Speaker setup –"Easy Setup"–	31
KRF-V9300D and KRF-V8300D Speaker setup –"Auto Setup"(Auto Room EQ)–.....	32
If a message is displayed	
Setting Room EQ	35
Speaker setup –"Manual Setup"–	36
Speaker configuration –"SP Setup"–	
Speaker level –"SP Level"–	
Speaker Distance –"SP Distance"–	
Other setups	38
Subwoofer Remix –"Subw Re-Mix"–	
Crossover –"Crossover"–	
LFE (Low Frequency Effect) level –"LFE Level"–	
Input assignment –"Assignment"–	
Audio delay –"Audio Delay"–	
HDMI setup	40
HDMI input setup –"HDMI Input"–	
HDMI setup –"HDMI Setup"–	
Audio Out	
Audio Delay (Lip Sync)	
HDMI Link	
Power Control	
TV Control	
TV AUDIO IN –"TV Audio In"–	
Locking the setups –"Setting Lock"–	42
Confirming the HDMI function	43
Before operation	
Confirming the basic HDMI operations	
Confirming the HDMI control functions	

Playing music or movie

Preparation for playing music or movie.....	44
Turning on the power	
Setting the speaker system	
Selecting the input mode	
Playback.....	45
Monitoring the input source in the original sound (STRAIGHT DECODE mode).....	45
Listening to music with PURE AUDIO MODE.....	46
KRF-V9300D Switching the video resolution....	47
Checking the HDMI audio input signal which output from the connected component.....	47
iPod control	48
Using the menus	

iPod operation.....	49
Play and pause	
File skip	
Fast forward and backward	
Repeat play	
Shuffle play	
Switching the display	
Switching the time information	

Surround effects

Listen mode	50
About indicators	
Surround play using the listen mode	51
Input signals and corresponding listen modes..	53
KRF-V9300D/KRF-V8300D Virtual mode.....	55
DVD 6 channel analog input	55

Listening to radio broadcasts

Tuning into a radio station	56
Using RDS (Radio Data System)	56
RDS Auto Memory.....	57
Presetting radio stations manually	57
Receiving preset stations	58
Receiving preset stations in order (P.CALL)	58
Tuning by program type (PTY search).....	58
Using the DISPLAY key.....	59

Recording

Recording mode setting in digital audio source recording.....	60
Recording audio (analog sources)	60
Recording video	60

Sound adjustment

Adjusting the sound	61
ACTIVE EQ mode	
Adjusting the Tone	
Bass Boost	
Adjustments according to the playing source..	62
Speaker level adjustment	
Input level adjustment	
Panorama mode	
Dimension	
Center width	
Center image	
Midnight mode	
Switching the main and sub audio	

Convenient functions

Convenient functions	65
Display dimmer adjustment	
Listening with headphones	
Muting the sound	
Remote control operations for Kenwood DVD players.....	66

Troubleshooting

Troubleshooting.....	67
Resetting the Microcomputer	
Glossary	69
Specifications	71

● **HDMI™(High-Definition Multimedia Interface) repeater function**

Compatibility with the HDMI interface can transfer HDTV video and latest high-quality audio. It makes possible entertainment of high-quality video recorded on Blu-Ray discs as well as high-quality audio including Dolby TrueHD, DTS-HD Master Audio and multi-channel PCM audio.

● **Video up-conversion**

KRF-V9300D

This function converts the analog video signal into a signal that can be output at the HDMI terminal.

Any video signal can be converted into HDMI video signal by simply connecting this unit to a TV through a commercially available HDMI cable (provided that your TV has an HDMI terminal). In addition, this unit also incorporates the upscaler function, which converts the analog video signal into an HDTV signal for enjoying high-quality video.

KRF-V8300D

This function converts the video signal output at the VIDEO and S-VIDEO terminal into a signal that can be output at the COMPONENT VIDEO terminal.

● **High-quality music playback in Pure Audio Mode**

This function reproduces music signals in high quality with high fidelity to original sound.

In this mode, the display and the analog video circuitry are turned off to eliminate their effects on the audio circuitry. In addition, the optimum listen mode is selected according to the input music signal.

● **iPod control**

This unit can control an iPod connected to it using the PNC-iP120 iPod connection cable (optional). The music can be reproduced from the speakers connected to this unit, and the video can be reproduced on the TV connected to this unit.

● **Auto Room EQ (KRF-V9300D and KRF-V8300D)**

A setup microphone is provided to measure the properties of the listening room and automatically set up the speakers accordingly. The automatic setup also includes the tone compensation according to the speaker characteristics and the listening room environment.

● **Audio Delay (Lip Sync) function**

This function corrects deviation between the video and audio. Automatic correction is also available provided that all of the playback component, this unit and the TV are connected through HDMI.

Manufactured under license from Dolby Laboratories. Dolby and the double-D symbol are trademarks of Dolby Laboratories.

iPod is a trademark of Apple Inc. in the United States and other countries.

Manufactured under license under U.S. Patent #s: 5,451,942; 5,956,674; 5,974,380; 5,978,762; 6,226,616; 6,487,535 & other U.S. and worldwide patents issued & pending. DTS is a registered trademark and the DTS logos, Symbol, DTS-HD and DTS-HD Master Audio are trademarks of DTS, Inc. © 1996-2007 DTS, Inc. All Rights Reserved.

HDMI, the HDMI logo and High-Definition Multimedia Interface are trademarks or registered trademarks of HDMI Licensing, LLC.

How to read this manual

The operating instructions given in this manual assume that the user mainly operates the receiver using the remote control unit. When the same operation is also available on the main unit, the operating method is indicated in illustrations. The [VOLUME CONTROL], [MULTI CONTROL] and [INPUT SELECTOR] knobs on the main unit are operated by turning the knobs clockwise or counterclockwise.

Before use

Speaker setup – "Manual Setup"–

Manual Setup is used to set up the speakers manually or to modify the setup made with Auto Setup.

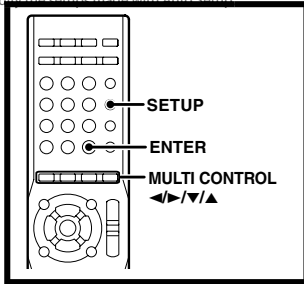

The knob on the main unit is pointed with an arrow to indicate that it can be turned in either direction.

The keys and controls used in the operations described in each section are indicated with their names.

The descriptions of the functions available only on the remote control unit are accompanied only with the illustration of the remote control unit. The descriptions of the functions available only on the main unit are accompanied only with the illustration of the main unit.

Speaker configuration – "SP Setup"–

Select the use of each speaker and its size.

1 Enter the Manual Setup mode.

[SETUP]



Use [MULTI CONTROL ◀/▶] to select "Manual Setup".



Manual Setup

[ENTER]

2 Select "SP Setup".

[MULTI CONTROL ◀/▶]



SP Setup

[ENTER]

3 Select the use and size of each speaker.

Use [MULTI CONTROL ◀/▶] to select the speaker.



FRNT Large

Use [MULTI CONTROL ▲/▼] to set its use or size.

FRNT Normal

Repeat the above operations until all of the speakers have been set up.

Speaker	Display	Setting
Subwoofer	"SUBW On"	Subwoofer is connected.
	"SUBW Off"	Subwoofer is not connected.
Front speaker	"FRNT Large"	Large size front speaker
	"FRNT Normal"	Average size front speaker

The names of the operated keys are enclosed inside brackets.

This icon indicates supplementary information, restrictions in operation or tips on operation.

When a key is used to select an option, the list of options is shown in the form of a table.

Continued

This icon indicates that the description continues on the next page.

Playback

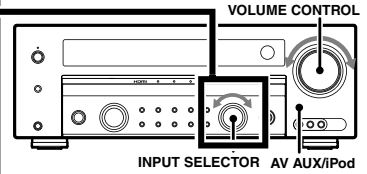

INPUT SELECTOR AV AUX/iPod

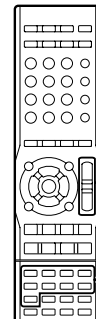

VOLUME ▲/▼

Input source keys

1 Select the source.

Use the Input source keys on the remote control unit to select a source. Or use [INPUT SELECTOR] knob or [AV AUX/iPod] key on the main unit.

2 Start playback from the selected source.

The iPod can be controlled from this unit. (See <iPod control> –[48].)

3 Use [VOLUME ▲/▼] to adjust the volume.

4 Enjoy various surround effects.

You can enjoy a variety of listen modes. (See <Surround play using the listen mode> –[51].) The surround effects can be fine tuned according to the selected input source. (See <Adjustments according to the playing source> –[62].)



The AV AUX and iPod inputs cannot be selected with the [INPUT SELECTOR] knob of this unit. These inputs should be selected using the [AV AUX/iPod] on this unit or the [AV AUX] or [iPod] key on the remote control unit.



- In this manual, KRF-V9300D is used for the illustrations of front panel and rear panel.
- The illustrations of the main unit display panel and the examples of operations are shown for the purpose of explanation and may differ from the actual view or operation.

iPod models usable with this unit

- To connect an iPod, you will need the iPod connection cable PNC-iP120 (optional accessory).
- This unit does not come with an iPod. It is up to you to purchase an iPod separately.
- Controllable iPod (As of July 2008)

Controllable iPod

iPod 4th Generation (Click wheel)

iPod mini

iPod 4th Generation (Color display)

iPod nano 1st Generation

iPod nano 2nd Generation

iPod video (iPod 5th Generation)

iPod photo

iPod nano 3rd Generation

iPod classic

iPod touch*

* With iPod touch, only the "Music" is compatible.

- Update the software of your iPod to the latest version.
- Some functions of iPod may not work properly depending on the iPod models and the software version.
- This unit supplies power to your iPod, which means you can enjoy listening to music while charging your iPod. To do this, the unit must be turned on.
- Video output setting of iPod such as "TV OUT" and "TV Signal" needs to be set on your iPod.

Handling precautions

- Be sure to read the instruction manual that comes with the iPod you are using.
- Certain conditions while using an iPod can cause contents stored on the iPod to be lost. Note that Kenwood will not be held liable for any losses arising out of loss of stored contents.

Displayable characters

- This unit can display alphanumeric and some symbol characters. It displays accented characters after converting them into ordinary alphabet characters. The non-displayable characters are displayed as "*".

Maintenance of the unit

When the front panel or case becomes dirty, wipe with a soft, dry cloth. Do not use thinner, benzine, alcohol, etc. for these agents may cause discoloration.

In regard to contact cleaner

Do not use contact cleaners because it could cause a malfunction. Be specially careful not to use contact cleaners containing oil, for they may deform the plastic component.

▶ / ||

▶ lights up during playback and || lights up during play-pause of the iPod.

SP(speaker) A/B

The indicator(s) corresponding to the front speakers in use lights up.

**KRF-V9300D/
KRF-V8300D:**

AUTO ROOM EQ

Lights up during measurement by Auto Room EQ or when Room EQ is on.

iPod

Lights up when an iPod is connected.

AUTO DETECT

Lights up when the input mode is set to "Auto".

HDMI

Lights up when the components connected with HDMI are recognized.

ACTIVE EQ

Lights up when ACTIVE EQ is on.

MUTE

Blinks when muting is on.

CLIP

Lights up when the input level is too high.

STONE

Lights up when the tone setting is on.

Listen mode/Input signal format indicators

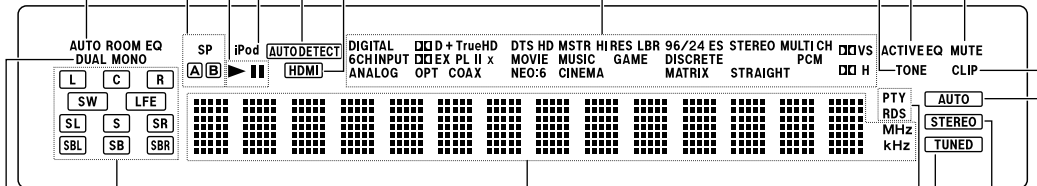

Input channel indicators

The indicators corresponding to the input channels (audio signal) used in the currently played music/video light up.

Character display

PTY

Lights up when searching a radio station by program type.

RDS

Lights up when receiving an RDS station.

TUNED

Lights up when a radio station is tuned.

STEREO

Lights up when stereo broadcasting is tuned.

AUTO

Lights up when the tuning mode is "Auto".

DUAL MONO

Lights up when the dual mono audio signal is input.

Remote control unit

Before use

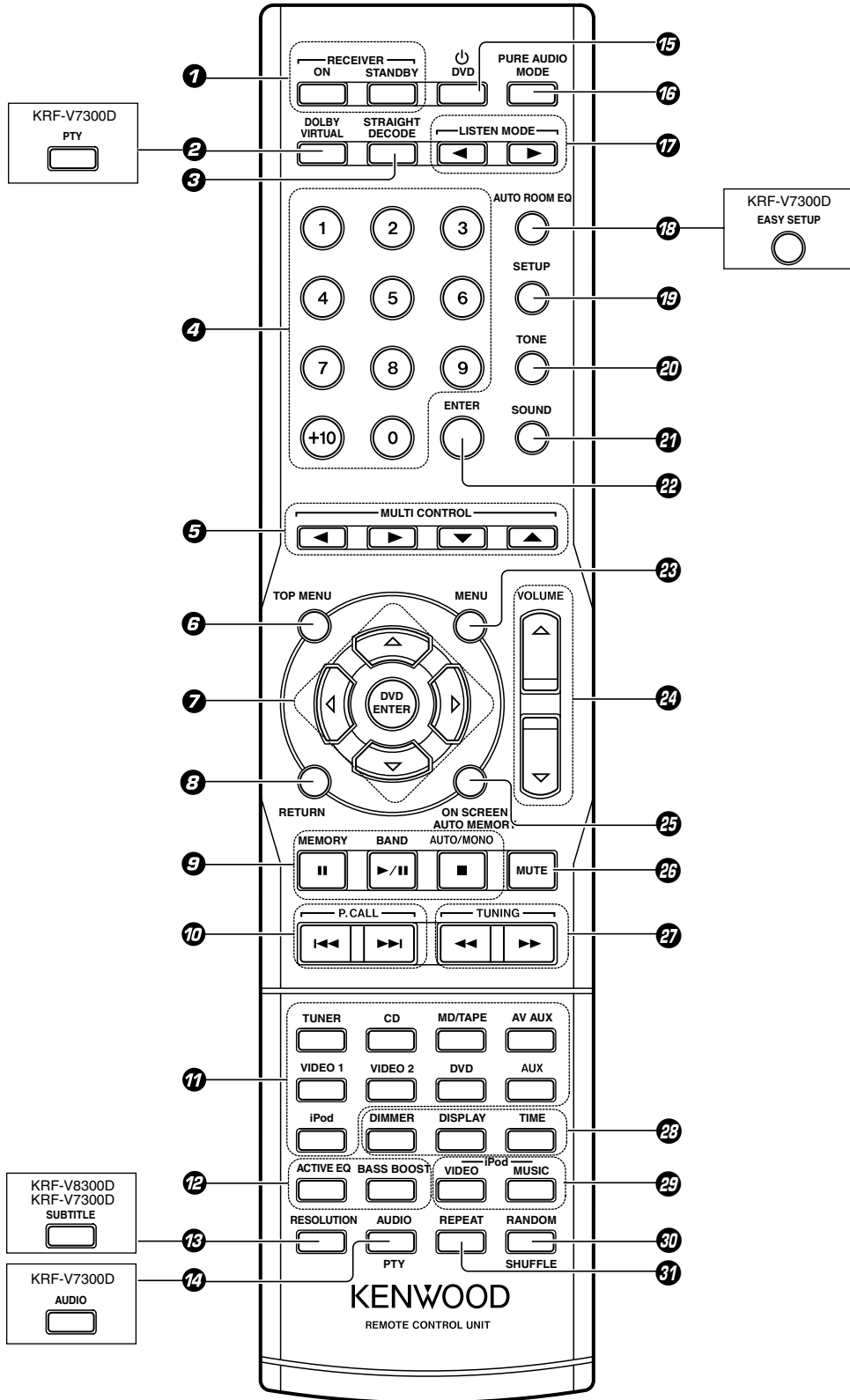

- 1 RECEIVER ON key**
Press to turn this unit ON.
- RECEIVER STANDBY key**
Press to put this unit to standby.
- 2 KRF-V9300D/KRF-V8300D: DOLBY VIRTUAL key** → 55
Press to switch the Dolby Virtual Speaker function or Dolby Headphone function ON/OFF.
- KRF-V7300D: PTY key** → 58
Press to search a radio station by program type.
- 3 STRAIGHT DECODE key** → 45
Press to switch the STRAIGHT DECODE mode ON/OFF.
- 4 Numeric keys**
Also used to recall a preset radio station. → 58
Use to operate the Kenwood DVD player.*
- 5 MULTI CONTROL ◀/▶/▼/▲ keys**
Press to select a setting item.
- 6 TOP MENU key**
Press to open the iPod menu. → 48
Use to operate the Kenwood DVD player.*
- 7 Δ/▽/◀/▶ keys**
DVD ENTER key
Use to operate the Kenwood DVD player.*
- 8 RETURN key**
Press during the iPod menu operation. → 48
Use to operate the Kenwood DVD player.*
- 9 MEMORY key** → 57
Press to preset radio stations in memory.
- II key**
Use to operate the Kenwood DVD player.*
- BAND key** → 56
Press to select the broadcasting band.
- ▶/II key**
Press to play/pause the music/video playback of iPod. → 49
Use to operate the Kenwood DVD player.*
- AUTO/MONO key** → 56
Press to switch the radio tuning mode between auto tuning and manual tuning.
- key**
Use to operate the Kenwood DVD player.*
- 10 P.CALL |◀◀/▶▶| keys**
Press to recall a preset radio station. → 58
Also press to skip an iPod track. → 49
Use to operate the Kenwood DVD player.*
- 11 Input source keys**
Press to select the input source.
- 12 ACTIVE EQ key** → 61
Press to switch the ACTIVE EQ function ON/OFF.
- BASS BOOST key** → 61
Press to enhance bass sound.
- 13 KRF-V9300D: RESOLUTION key** → 47
Press to switch the resolution of the HDMI video output as a result of conversion of an analog video signal.
- KRF-V8300D/KRF-V7300D: SUBTITLE key**
Use to operate the Kenwood DVD player.*
- 14 AUDIO key**
Use to operate the Kenwood DVD player.*
- KRF-V9300D/KRF-V8300D: PTY key** → 58
Press to search a radio station by program type.
- 15 ⏻ DVD key** → 66
Press to switch the Kenwood DVD player ON/OFF.
- 16 PURE AUDIO MODE key** → 46
Press to switch the PURE AUDIO MODE function ON/OFF.
- 17 LISTEN MODE ◀/▶ keys** → 51
Press to switch the listen mode.
- 18 KRF-V9300D/KRF-V8300D: AUTO ROOM EQ key** → 32
Press to perform auto setup of the speakers.
- KRF-V7300D: EASY SETUP key** → 31
Press to perform easy setup of the speakers.
- 19 SETUP key** → 30
Press to set up this unit.
- 20 TONE key** → 61
Press to adjust the tone.
- 21 SOUND key** → 62
Press to adjust sound quality and acoustic field.
- 22 ENTER key**
Press to enter the selected setting.
- 23 MENU key**
Use to operate the Kenwood DVD player.*
- 24 VOLUME Δ/▽ keys**
- 25 ON SCREEN key**
Use to operate the Kenwood DVD player.*
- AUTO MEMORY key**
Press to start auto memory of RDS and FM radio stations. → 57
- 26 MUTE key** → 65
Press to mute the sound temporarily.
- 27 TUNING ◀◀/▶▶ keys**
Press to select a radio station. → 56
Press to fast forward/fast backward the tracks in the iPod. → 49
Use to operate the Kenwood DVD player.*

28 DIMMER key → 65
Press to switch the brightness of the display and indicators.

DISPLAY key
Press to display the type and number of channels of the signal input at the HDMI input. (When the HDMI input is enabled) → 47

Press to display the information of the tracks in the iPod. → 49

Press to display RDS information. → 59

TIME key → 49
Press to display the time information of the tracks in the iPod.

29 iPod VIDEO key → 48
Press to select video menu of the iPod.

iPod MUSIC key → 48
Press to select music menu of the iPod.

30 RANDOM / SHUFFLE key
Press to switch the shuffle play of the iPod. → 49

Use to operate the Kenwood DVD player.*

31 REPEAT key
Press to switch the repeat play of the iPod. → 49

Use to operate the Kenwood DVD player.*



- * For how to be able to use the keys to operate the Kenwood DVD player, see <Remote control operations for Kenwood DVD players>. → 66

Loading batteries

1 Remove the cover.

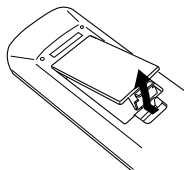

2 Insert batteries.

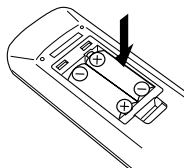

Insert two (R03) batteries following the polarity indications.

3 Close the cover.

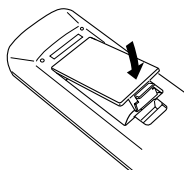

- The supplied batteries may have shorter lives than ordinary batteries due to use during operation checks.
- When the remote-controllable distance gets shorter than before, replace both batteries with new ones.

CAUTION

Do not leave the battery near fire or under direct sunlight. A fire, explosion or excessive heat generation may result.

Operation

Operate the remote control unit by pointing it to the remote sensor of this unit.

When this unit is in standby mode (which is indicated by lighting of the standby indicator), pressing the [ON] key turns this unit ON. Pressing the [STANDBY] key turns this unit OFF (standby mode).

When operating the connected components, always press the input source key of the component you need to operate first to switch the remote control unit to the selected input source mode, and then press the keys of the corresponding operation.

Operating range (Approx.)

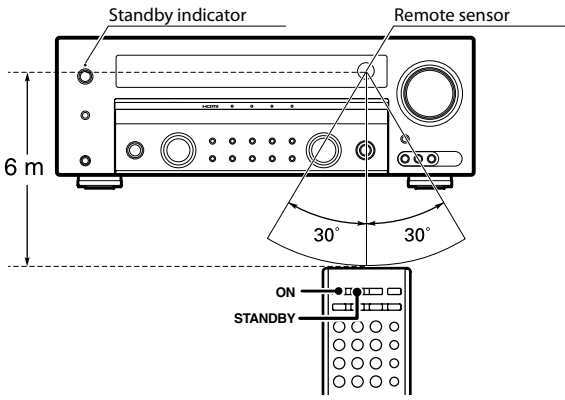

Notes on connections

⚠ CAUTION

Do not connect the power cord to a wall outlet until all connections are completed.

When connecting the related system components, be sure to refer to the instruction manuals supplied with the components you are connecting.



Connections

- Be sure to remove the power cord from the AC outlet before plugging or unplugging any connection cords. Plugging/unplugging connection cords without disconnecting the power cord can cause malfunctions and may damage the unit.
- Be sure to insert all connection cords securely. If their connections are imperfect, the sound and video may not be produced or there will be noise interference.
- If this unit is installed in the proximity of a source of magnetism such as a magnet, color irregularities due to interference with the speakers may be observed on the TV monitor screen. Be careful in the installation.

Microcomputer malfunction

If operation is not possible or an erroneous display appears, even though all connections have been made properly, reset the microcomputer by referring to <Resetting the microcomputer>.

— 68

⚠ CAUTION

The power of this equipment will not be completely cut off from the wall outlet when the power switch is turned off. Install the equipment so that the wall outlet is easily accessible and, in case of emergency, immediately unplug the power cord from the wall outlet.

⚠ CAUTION

Be sure to adhere to the following, or proper ventilation will be blocked causing damage or fire hazard.

- Do not install the unit on the rear, side or top panel.
- Do not cover the unit with a cloth or install the unit on a carpet or mattress.
- Do not install the unit in a poorly ventilated place.
- This unit is using the cooling fan. Do not place the unit onto a bed, a sofa, a carpet, or similar. Sucked-in dust can cause fire.
- Leave some space around the unit (from the largest outside dimension including projection) equal to or greater than, shown below.

Side panel : 10 cm

Back panel : 10 cm

Speaker placement

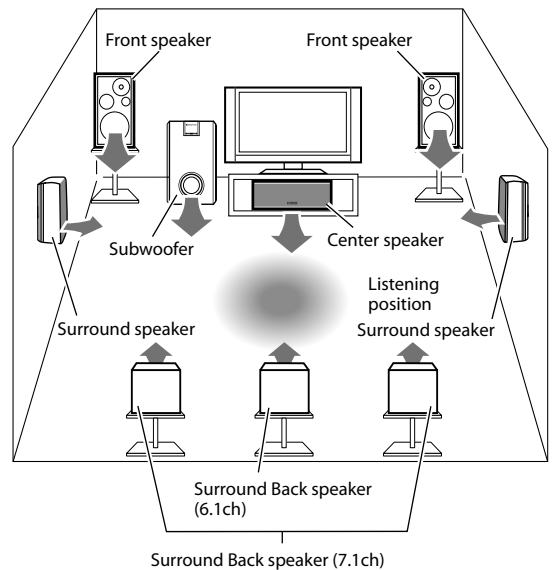

Front speakers

Install in the front left and right positions. Symmetrical installation is ideal. The front speakers are always used regardless of the listen mode.

Center speaker

Install in the front center position. This speaker improves the acoustic image positioning and reproduction of sound movement.

Surround speakers

Install straight on or slightly behind the left and right of the listening position, at an as high as possible height (ideally one meter above the height of the listener's ears). Symmetrical installation is ideal. The surround speakers reproduce the feeling of movement and presence of sound.

Subwoofer

In general, install on the front center position near the front speakers. The subwoofer reproduces the powerful bass effects. As it is less directional to other speakers, it can be installed so that the bass can be reproduced best according to the listening room layout.

Surround Back speakers

Install on the rear of the listening position, at the same height as the surround speakers.

When only one surround back speaker is installed, the system becomes a 6.1-channel surround system. When two surround back speakers are installed, it becomes a 7.1-channel surround system.



- Ideal surround play is possible when all of the speakers above are installed. If the center speaker and/or the subwoofer is not installed, the system optimizes playback according to the current system by assigning the sound of absent channels to other speakers.

Connecting components equipped with HDMI terminals

The HDMI connection can transfer both the video and audio signals through a single HDMI cable. It makes possible entertainment of high-quality video recorded on Blu-ray discs as well as high-quality audio including Dolby TrueHD, DTS-HD Master Audio and multi-channel PCM audio. The HDMI connection also enables interlocking of the power of the TV with that of this unit and adjustment of the volume of this unit from the TV. (See <HDMI setup> → [40](#).)

1 Using an HDMI cable, connect the HDMI input terminal ([DVD IN] or [VIDEO2 IN] terminal) of this unit to the HDMI output terminal of a playback component such as a DVD player.

2 Using another HDMI cable, connect the [HDMI MONITOR OUT] terminal of this unit to the HDMI input terminal of the TV monitor.

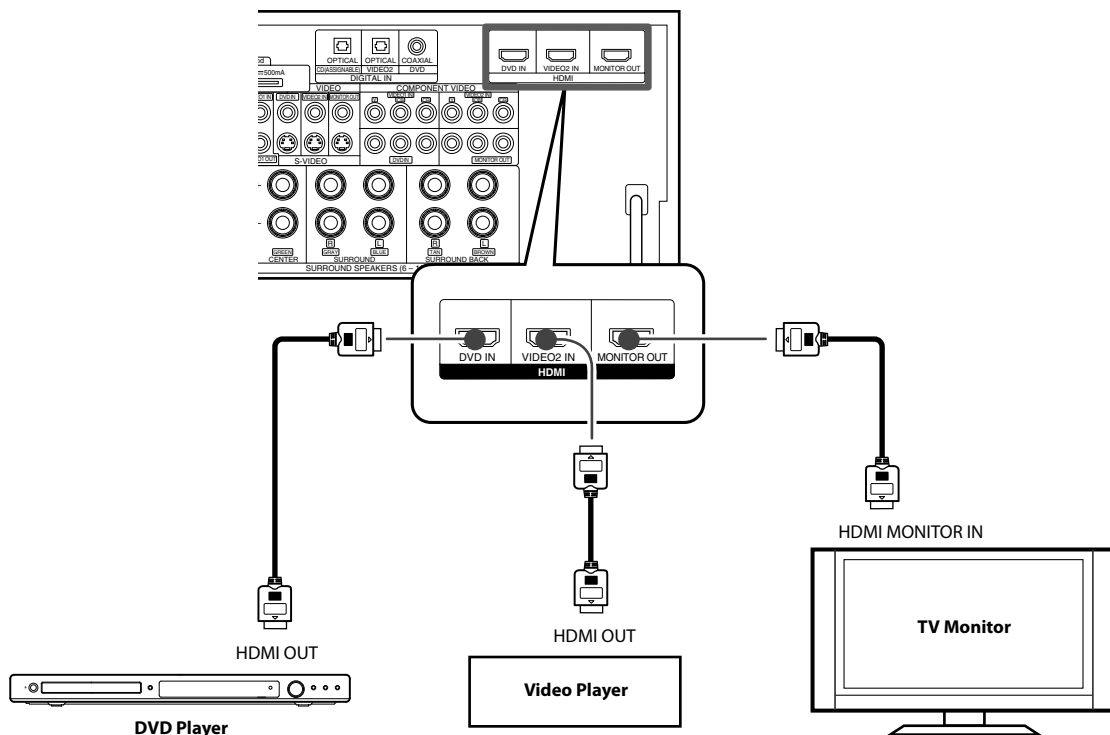

Using the HDMI function

The HDMI setup is required to use the HDMI function. First enable the HDMI input as described in <HDMI input setup - "HDMI Input"> → [40](#).

Flow of video signal

The digital video signal input from the HDMI input terminal is output only at the HDMI monitor output terminal.

KRF-V9300D only :

The video up-conversion function can output the video signal input from the VIDEO, S-VIDEO and COMPONENT VIDEO terminals at the HDMI output terminal. (See <Video up-conversion function> → [18](#).)

Flow of audio signal

The digital audio signal input from the HDMI input terminal is output at the speakers connected to this unit. It can also be output at the TV monitor connected to this unit according to the HDMI setup. (See <HDMI setup> → [40](#).)



- An HDMI/DVI converter cable is necessary to connect a TV monitor with a DVI input terminal. The TV monitor also needs to be compatible with HDCP (High-bandwidth Digital Contents Protection). Note that the video may be unable to be monitored depending on the combined components.
- Use an HDMI-certified category 2 cable (High Speed HDMI™ Cable) for the connection.
- When components are connected through the HDMI connection, it takes a certain period before the video/audio are output because they need mutual authentication.
- If the video and/or audio are not output normally, turn all of the connected components off then on, and try again.

Connecting a TV Monitor

1 Connect the TV monitor by selecting one of the desired method from connections **B**, **C**, **D** and **E** shown on the right page.

For the video and audio connections of the connected component, see the description on the page for the connected components.

KRF-V9300D and KRF-V8300D:

This unit is capable of up-conversion of video signals.

For KRF-V9300D, when the TV monitor is connected to this unit through HDMI connection (connection **B**), any video signal input to this unit can be output at the HDMI monitor output terminal.

For KRF-V8300D, VIDEO and S-VIDEO signal can be converted to COMPONENT VIDEO signal (connection **C**).

For details, see <Video up-conversion function> → **18**.

2 To output the audio of the TV monitor from the speakers connected to this unit:

Use connection **A (digital) or **F** (analog).**

Use the digital connection (connection **A**) to enjoy digital surround broadcasting, etc. in a surround system environment.



- The HDMI video cannot be viewed unless the TV monitor is equipped with the HDMI terminal.

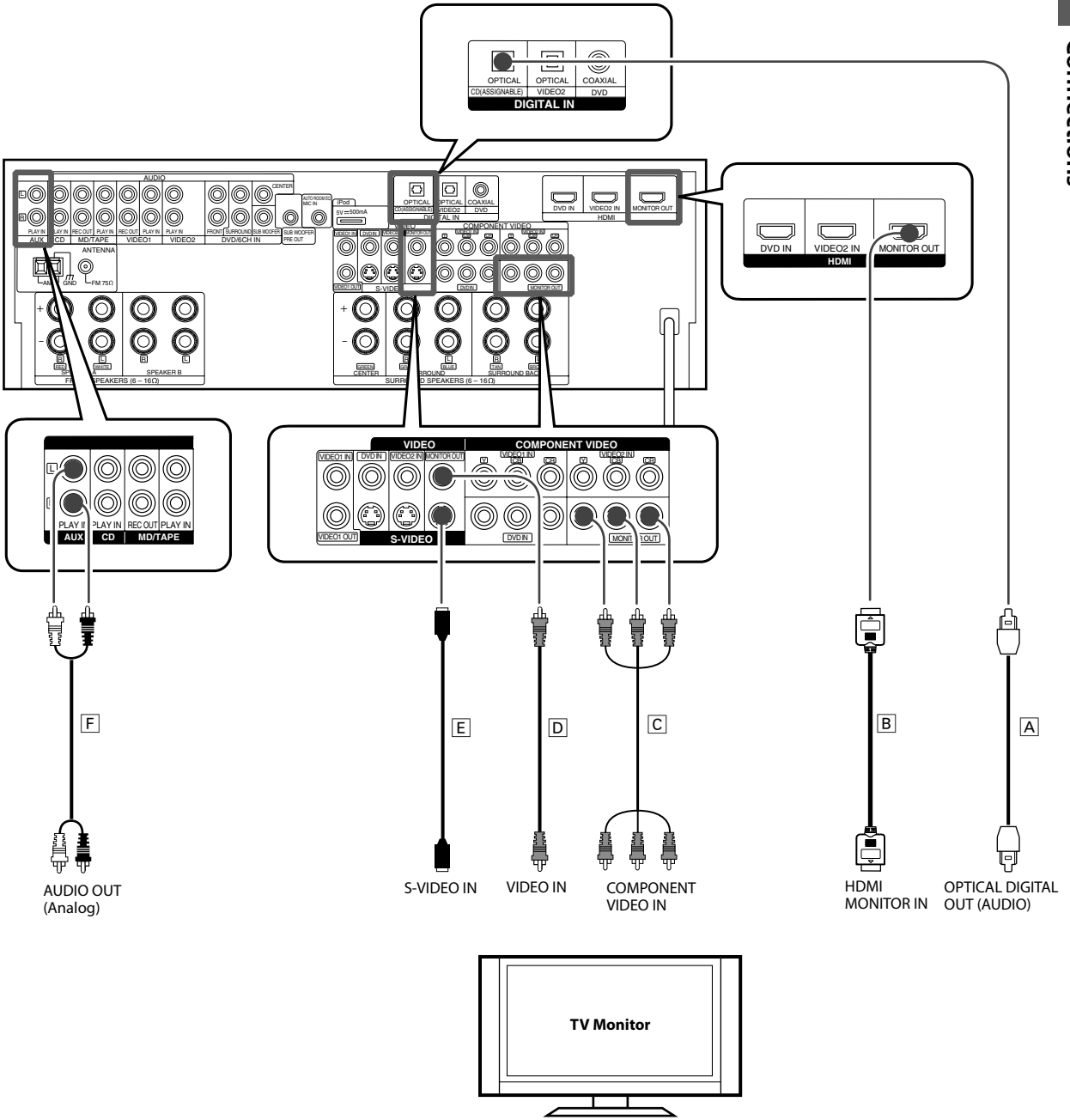

Video up-conversion function (KRF-V9300D and KRF-V8300D)

This function converts and outputs the analog video signal input to this unit to the HDMI or other video signal format according to the connected monitor.

This unit is compatible with the following video signal formats.

- Digital video signal: HDMI
- Analog video signals: COMPONENT VIDEO, S-VIDEO, VIDEO

■ KRF-V9300D

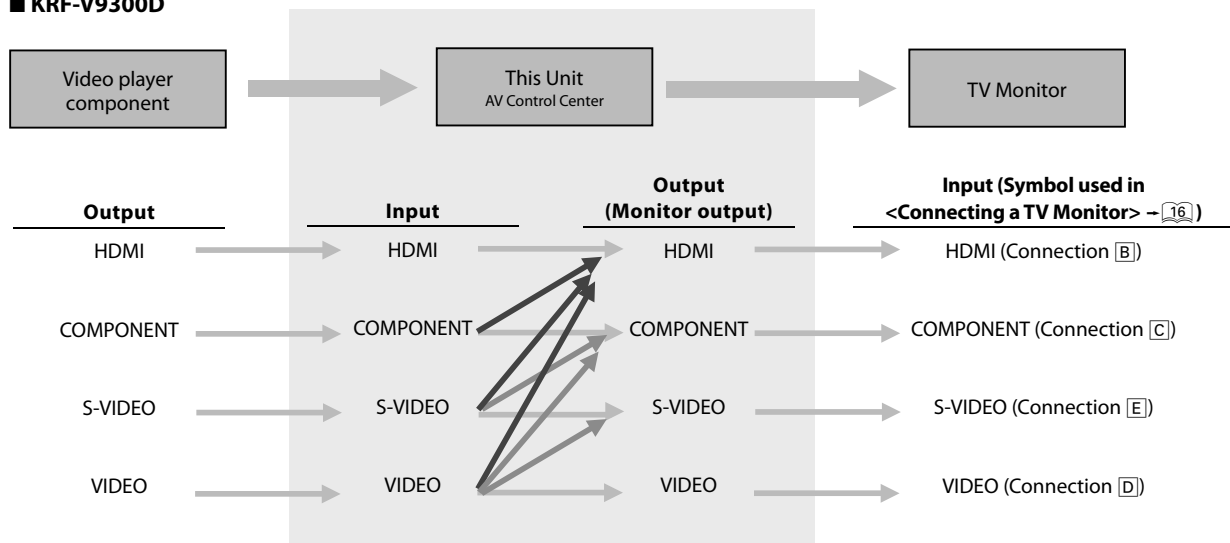

■ KRF-V8300D

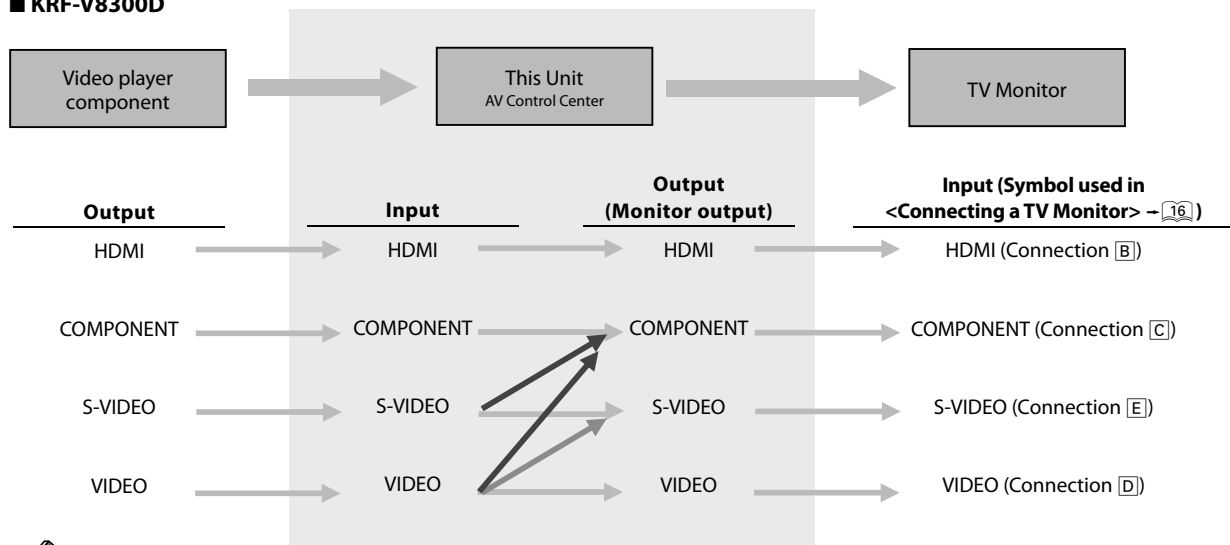

- To output the video signal from the HDMI monitor output, enable the video input in the HDMI setup. (See <HDMI input setup - "HDMI Input" -> - [40].)
- When the video signal input from the VIDEO or S-VIDEO terminal is output at the COMPONENT VIDEO terminal, the video resolution becomes 576i (or 480i).
- The video signal from a VCR may be disturbed or non-displayable in certain cases.
- The picture quality of the converted video may be degraded (for example, the screen is flickered, the text is not displayed clearly, and etc.) In this case, output the video signal from the TV monitor output terminal for the same format as the video input terminal used.
- This unit is compatible with the PAL and NTSC TV formats.
- KRF-V9300D only:
When the video signal input from the VIDEO, S-VIDEO or COMPONENT VIDEO terminal is converted and output at the HDMI output, the resolution of the video signal can be selected. (See <Switching the video resolution> - [47].)

Connecting a CD player

1 Connect the audio line: Connection **A** (digital) or **B** (analog).

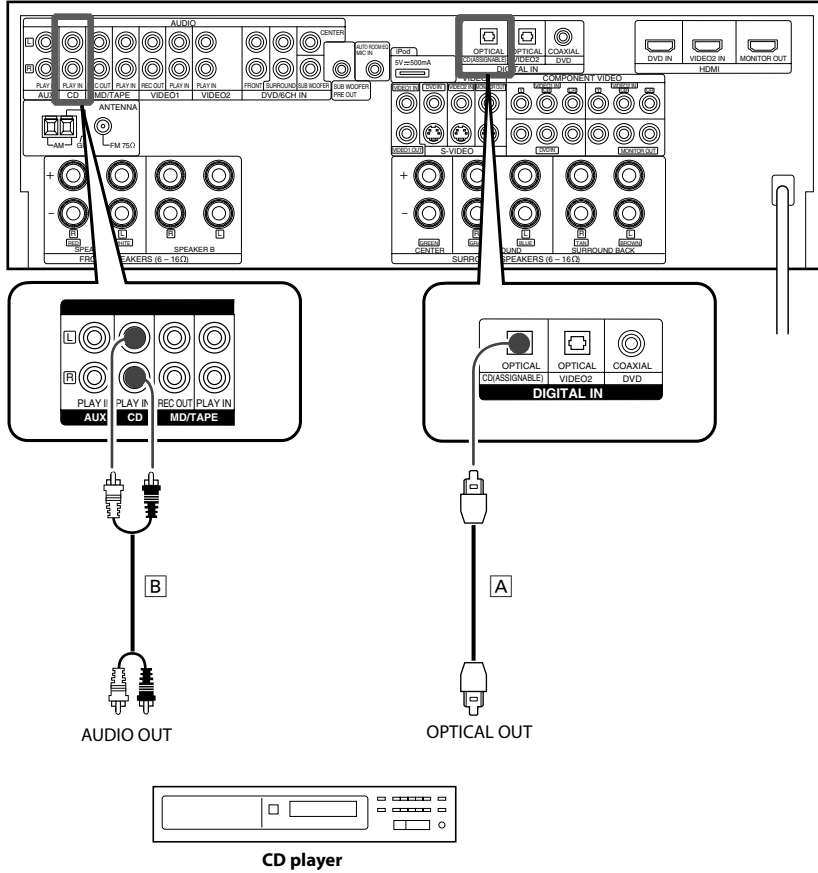

- If connection **A** is used, assign the input source to "CD". (See <Input Assignment – "Assignment"> → [39](#).)

Connecting a DVD player

1 Connect the audio line: Connection **A** (digital) or **E** (analog).

2 Connect the video line: Connection **B**, **C** or **D**.

3 Connect the TV monitor.

Connect as shown in <Connecting a TV Monitor> → **16**.

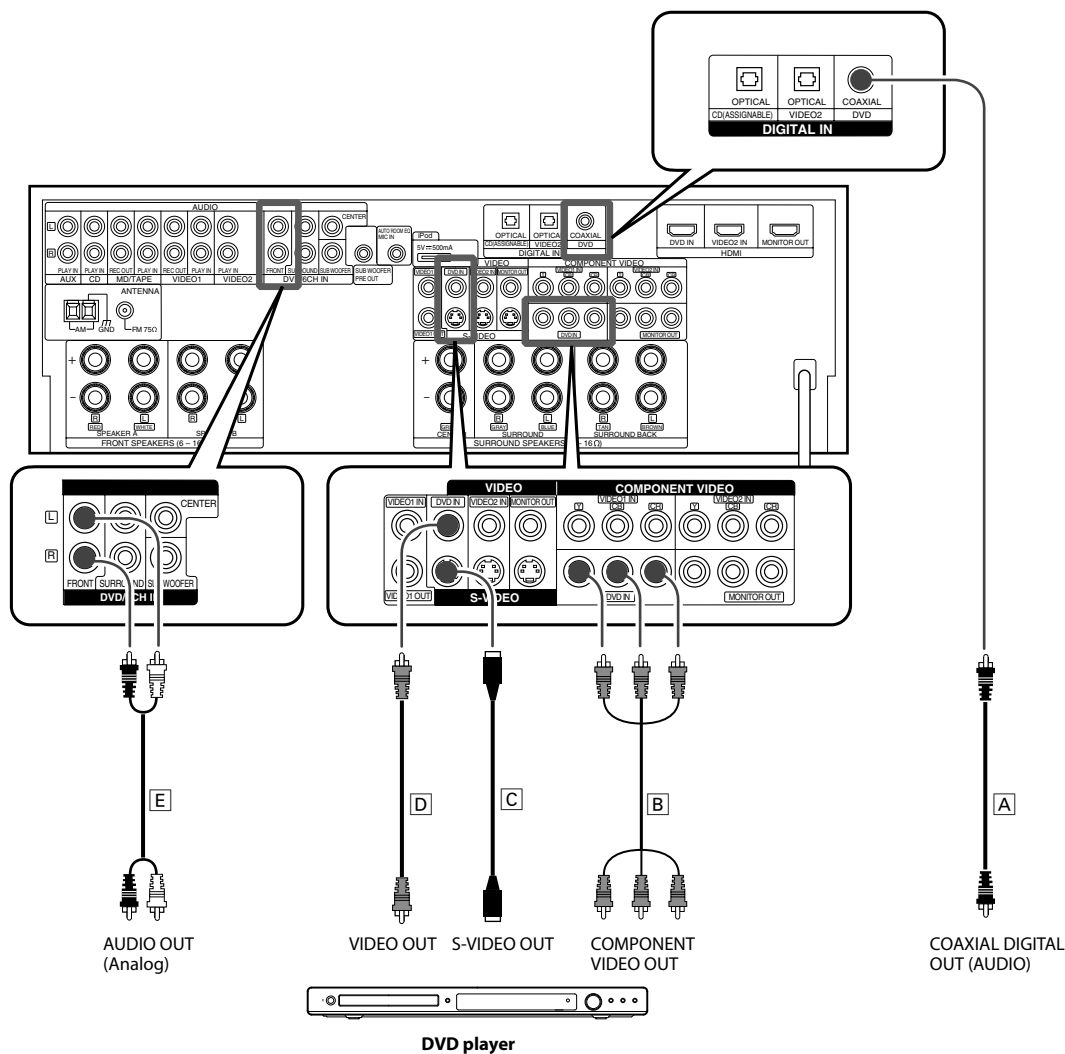

- Disable the HDMI input if making the connection above. (See <HDMI input setup - "HDMI Input"> → **40**.)
- When the connected DVD player and/or TV monitor have the HDMI terminals, it is recommended to use the HDMI connection. (See <Connecting components equipped with HDMI terminals> → **15**.)

Connecting a DVD player with multi-channel audio output terminal

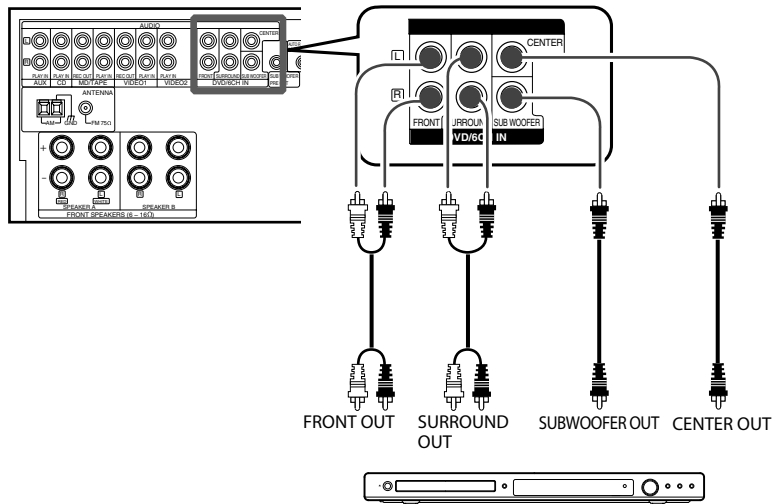

- Disable the HDMI input if making the connection above. (See <HDMI input setup -"HDMI Input"-> → [40](#).)
- For the VIDEO line connection, see <Connecting a DVD player> → [20](#).

Connecting the video player component

- 1** Connect the audio line: Connection **A** (digital) or **E** (analog).
- 2** Connect the video line: Connection **B**, **C** or **D**.
- 3** Connect the TV monitor.

Connect as shown in <Connecting a TV Monitor> → [16](#).

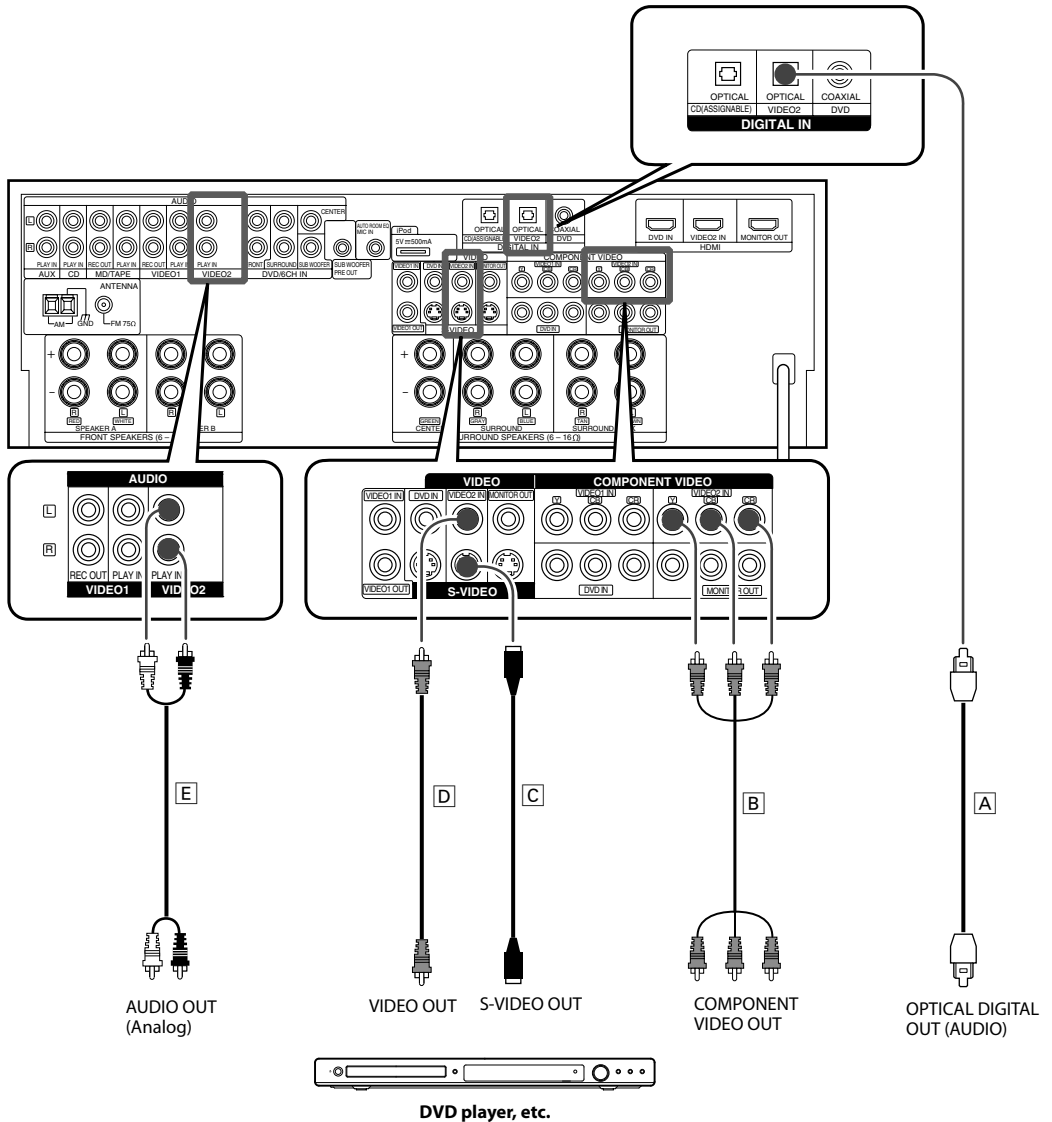

- Disable the HDMI input if making the connection above. (See <HDMI input setup - "HDMI Input"> → [40](#).)
- When the connected Video player and/or TV monitor have the HDMI terminals, it is recommended to use the HDMI connection. (See <Connecting components equipped with HDMI terminals> → [15](#).)

Connecting the video recorder component

- 1** Connect the audio line: Connection **B**.
- 2** Connect the video line: Connection **A**.
- 3** Connect the TV monitor.

Connect as shown in <Connecting a TV Monitor> → **16**.

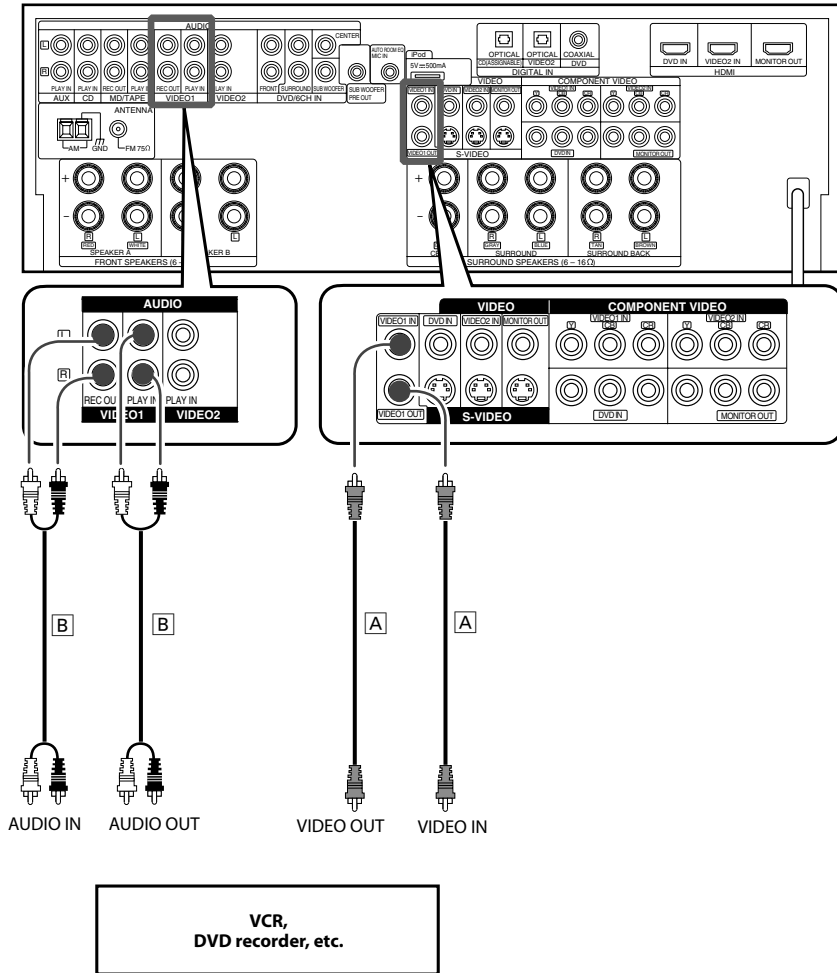

Connecting an iPod

The PNC-iP120 (optional) is necessary to connect an iPod to this unit.

For the usable iPod models, see < iPod models usable with this unit > → 7.

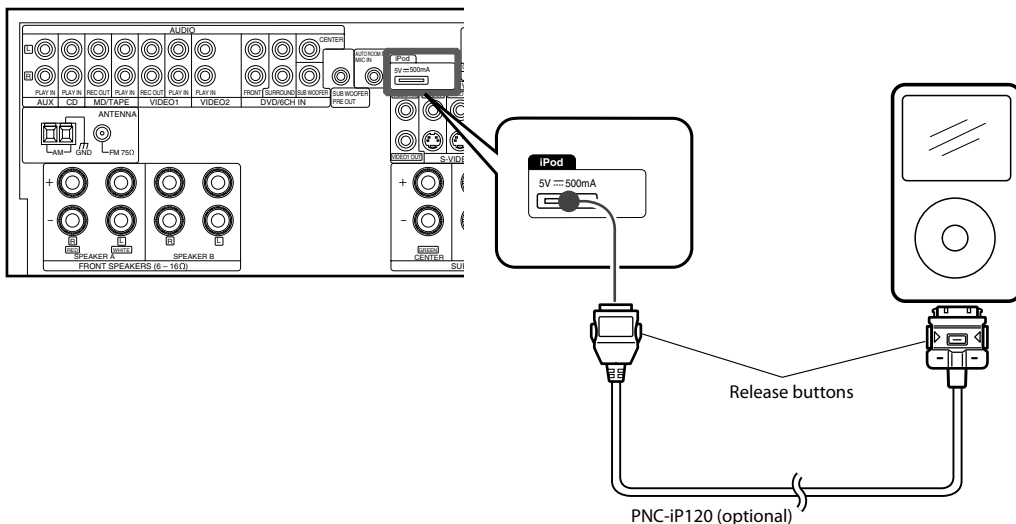

Display when an iPod is connected

When an iPod is connected and the iPod input source is selected, the display shows the connection status of the iPod.

"Reading" (Blinking):

iPod is being recognized.

"Connected" :

iPod has been recognized. Now this unit can control the iPod.

"Connect Error" :

The connection is erroneous.

- ➔ Disconnect the iPod and connect it again.

The iPod in use is not compatible with this unit.

- ➔ Connect an iPod compatible with this unit by referring to < iPod models usable with this unit > → 7.

The software version of the iPod may be obsolete.

- ➔ Update the software version of the iPod by referring to < iPod models usable with this unit > → 7.

The battery is low.

- ➔ Wait until the battery is charged.

"Disconnect" :

The iPod is disconnected.



- Turn this unit OFF (standby mode) before connecting the iPod.
- Insert the iPod connection cable all the way, until it clicks.
- To disconnect the iPod, hold the release buttons on both sides of the connector of the iPod connection cable and pull the connector. To prevent damage, do not pull the connector with an excessive force.
- While the iPod is connected to this unit, the iPod can be controlled from this unit or the remote control unit provided with it. When the iPod is connected to this unit, it cannot be used to control its operations.

Connecting an MD recorder / a cassette deck

1 Connect the audio line: Connection **A** and **B**.

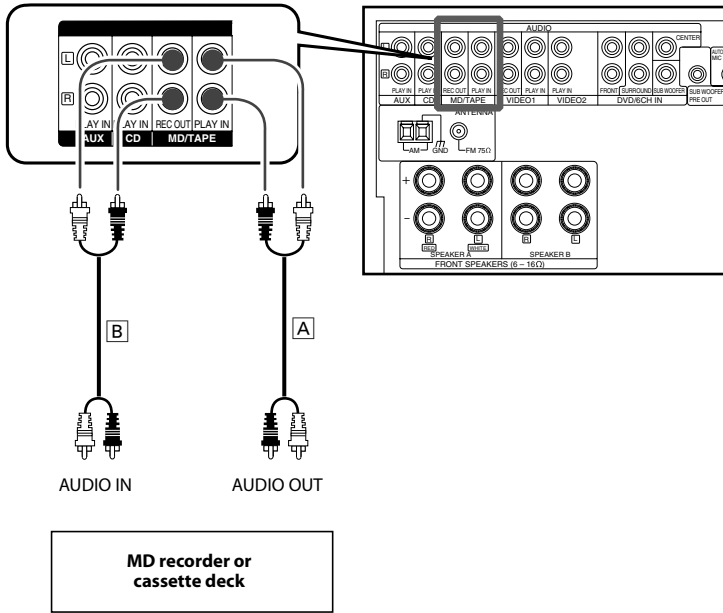

- Connection **B** is not necessary if the connected component is not used for recording.

Connecting to the [AV AUX] jacks

A component that is usually not connected to this unit, such as a portable video camera, can be connected to the [AV AUX] jacks on the front panel of this unit.

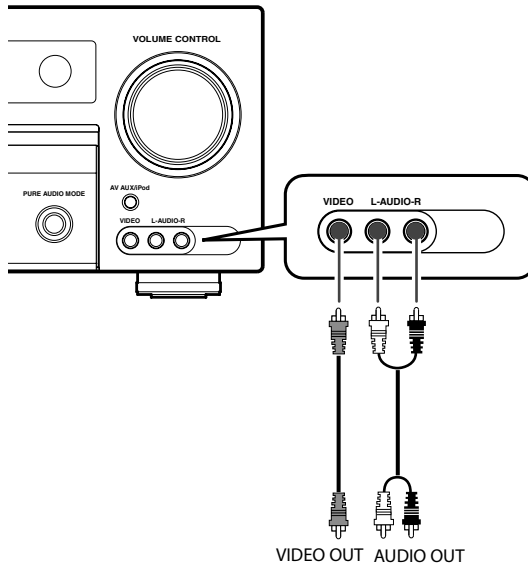

Connecting speakers

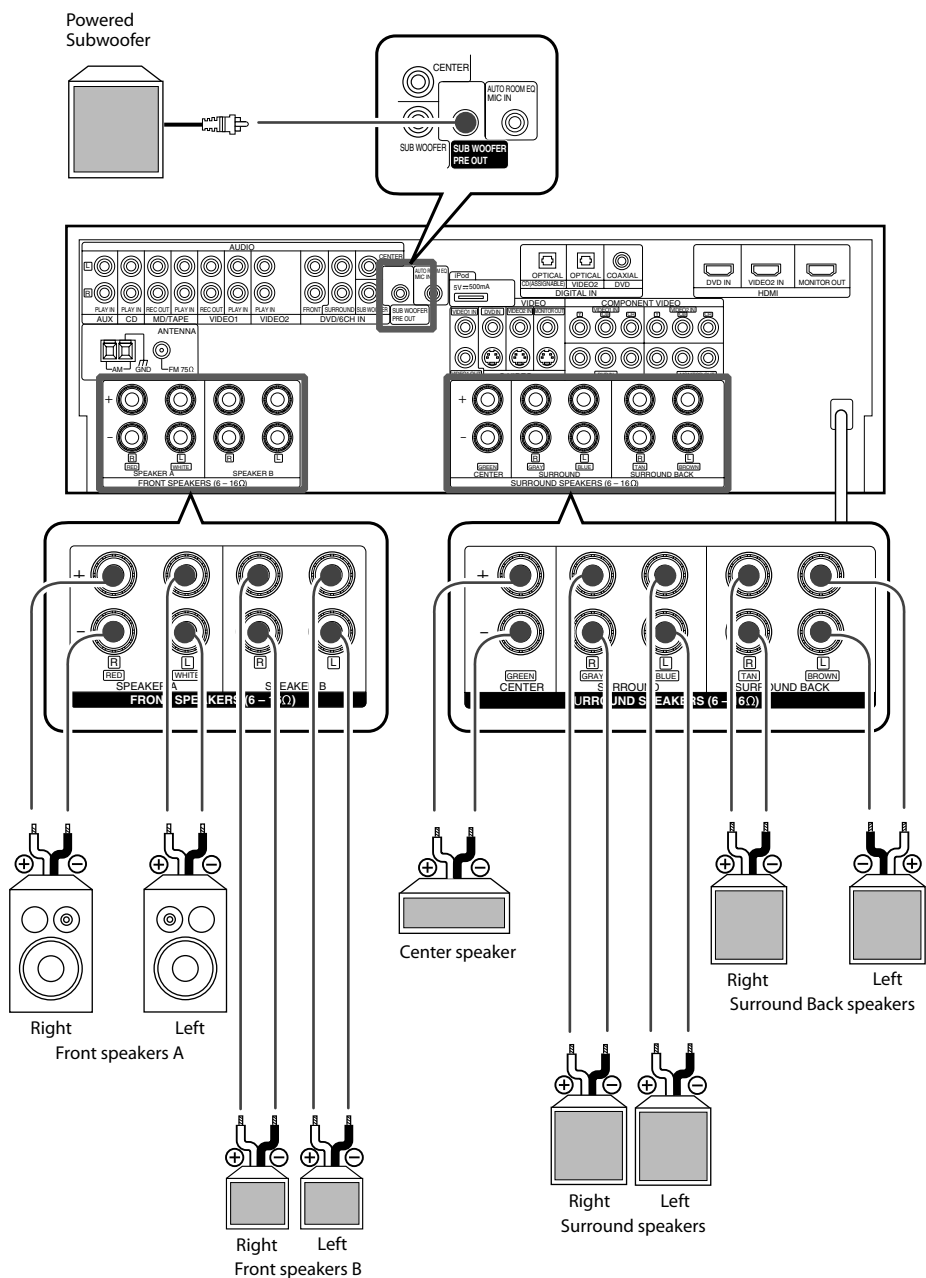

- Speaker impedance : 6 – 16Ω
- Never short circuit the + and – speaker cords.
- If the left and right speakers are connected inversely or the speaker cords are connected with reversed polarity, the sound will be unnatural with ambiguous acoustic imaging. Be sure to connect the speakers correctly.
- When only one surround back speaker is used, connect it to the [SURROUND BACK L] terminal.
- When connecting the second set of front speakers or a set of speakers installed in another room, connect them to the [SPEAKER B] terminals.

How to connect the wire to terminals

- 1** Strip the vinyl coating of the wire by a length of about 1 cm.



- 2** Loosen the knob.

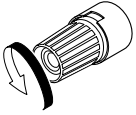

- 3** Insert the wire.

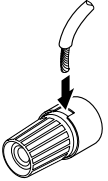

Insert until the metallic conductor becomes invisible.

- 4** Tighten the knob.

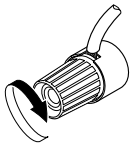

Connecting antennas

The broadcast reception cannot be made unless the antennas are connected. Connect the antennas correctly as instructed below.

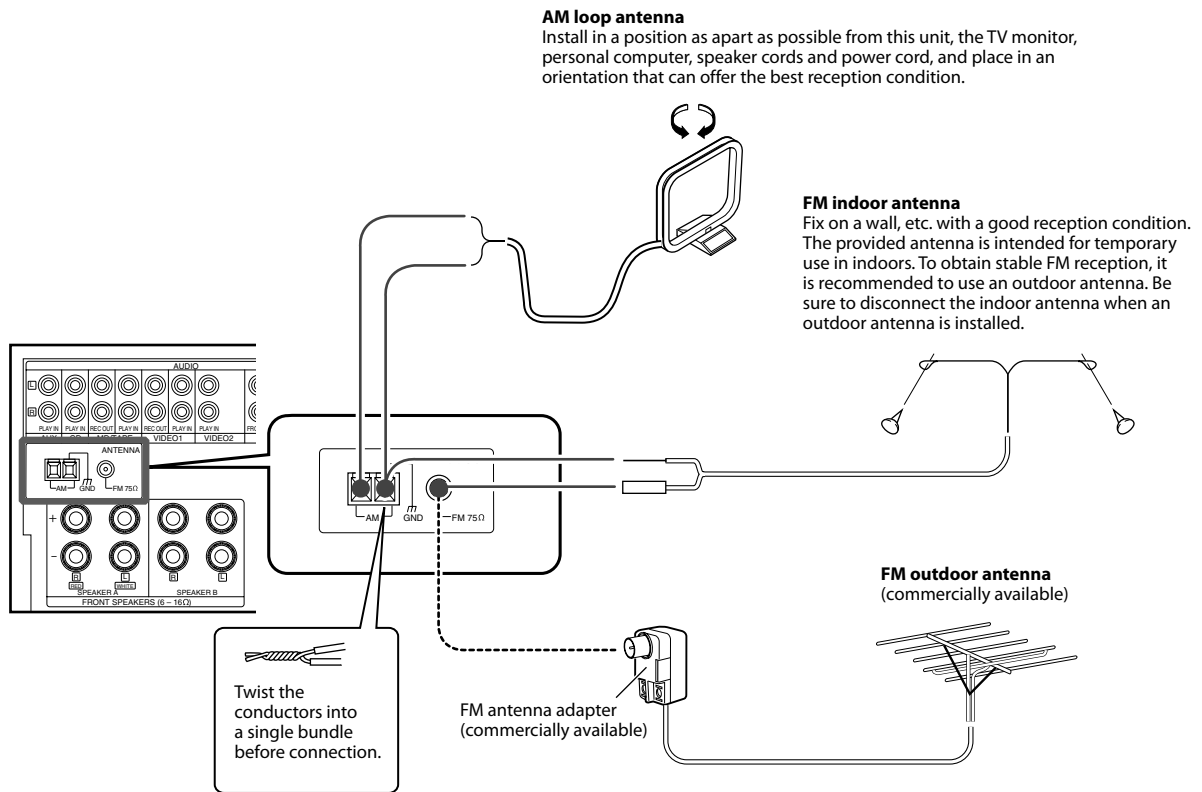

AM loop antenna

1 Attach to the stand.

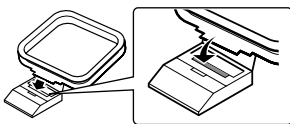

Insert into the groove.

2 Push the lever.

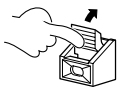

3 Insert the antenna cord.

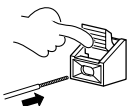

Insert until the metallic conductor becomes invisible.

4 Release the lever.



FM indoor antenna

1 Insert the antenna cord.



FM outdoor antenna

Lead the 75Ω coaxial cable connected to the FM outdoor antenna into the room and connect it to the FM 75Ω terminal.

Turning this unit ON

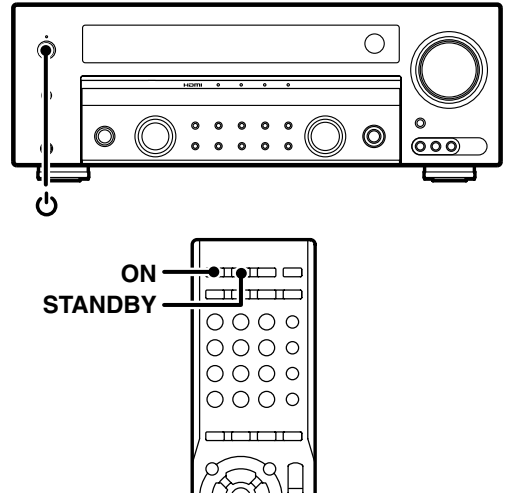
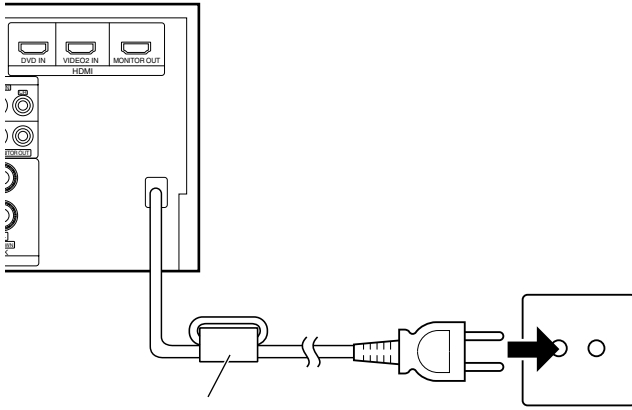

1 After completing all of the necessary connections, connect the power cord to a wall power outlet.

The standby indicator on the front panel lights red to indicate the standby mode.

2 Press the [⏻ (Power)] key of this unit or the [ON] key of the remote control unit to turn this unit ON.

The standby indicator on the front panel goes out and the display panel lights up.

To turn this unit OFF (standby mode)

Press the [⏻ (Power)] key of this unit or the [STANDBY] key of the remote control unit.

Setup menu and its operations

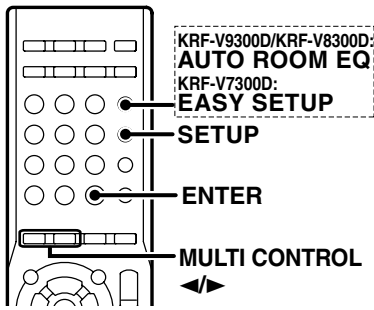

1 Press [SETUP] to enter the setup mode.

KRF-V9300D and KRF-V8300D :
The "Auto Setup" mode can also be initiated by pressing the [AUTO ROOM EQ] key.
KRF-V7300D :
For Easy Setup mode, press the [EASY SETUP] key.

2 Use [MULTI CONTROL ◀/▶] to select an item and press [ENTER].

If a submenu is opened, select one of its items with the same procedure.

3 Perform setup by referring to the page describing the selected item.

	Setup Menu	Submenu	Setting details	page
KRF-V7300D only	"Easy Setup"*		The speaker setup is possible by simply selecting the listening room size and the listening position. If a finer setup is required, please use "Manual Setup".	→ 31
KRF-V9300D and KRF-V8300D only	"Auto Setup"	"Room EQ"	Sets whether or not the equalizer curve obtained with "Auto Setup" is used.	→ 35
		"Calibrate"	Measures and analyzes the properties of the speakers and listening room.	→ 32
		"Confirm"	Confirms the results of Auto Setup.	→ 32
		"Return"	Returns to the setup menu.	
Common for all models	"Manual Setup"	"SP Setup"	Selects the use of each speaker and its size.	→ 36
		"SP Level"	Adjusts the speaker output levels.	→ 37
		"SP Distance"	Sets the distance between each speaker and the listening position.	→ 37
		"Return"	Returns to the setup menu.	
	"Subw Re-Mix"		Mixes the bass tone of other channels to the subwoofer channel.	→ 38
	"Crossover"		Sets the lower limit of the bass frequencies reproduced from the speakers set to "Normal" in the "SP Setup". The frequencies below the frequency set here are distributed to other speakers (those set to "Large" and the subwoofer).	→ 38
	"LFE Level"		Adjusts the bass tone in reproduction of Dolby Digital and DTS sources.	→ 38
	"Assignment"		Assigns the input source to the signal output at the CD (ASSIGNABLE) terminal on the rear panel.	→ 39
	"Audio Delay"		Adjusts the deviation in time between the video and audio.	→ 39
	"HDMI Input"		Enables or disables the HDMI input. Enabling the HDMI input makes it possible to use the variety of HDMI functions.	→ 40
	"HDMI Setup"	"Audio Out"	Sets whether the HDMI audio input is output from the speakers connected to this unit or from the TV.	→ 41
		"Audio Delay"	Adjusts the deviation in time between the HDMI video and audio.	→ 41
		"HDMI Link"	Switches the HDMI control functions ON/OFF. Setting this item to ON makes it possible to interlock the power of the TV and this unit (Power Control) and to control the volume of this unit from the TV (TV Control).	→ 41
		"Return"	Returns to the setup menu.	
	"TV Audio In"		Setting this item to ON makes it possible to enjoy digital surround broadcasting, etc. in the surround environment. When this is set to ON, the input selector of this unit is automatically switched to "OPT 1" when the input of the TV is switched.	→ 42
	"Setting Lock"		Locks the setups of this unit.	→ 42
	"Exit"		Exits the setup menu.	

* The Easy Setup mode cannot be initiated with the [SETUP] key. Use [EASY SETUP] key.

To exit the setup menu

Select "Exit" in the setup menu or press [SETUP] while in the setup mode.

KRF-V7300D Speaker setup – "Easy Setup" –

The speaker settings can be completed by simply selecting the room type and listening position. The audio will be corrected automatically according to the characteristics of the speaker system in use.

If more detailed speaker settings are required, use the procedure in <Speaker setup – "Manual Setup" –> → [36].

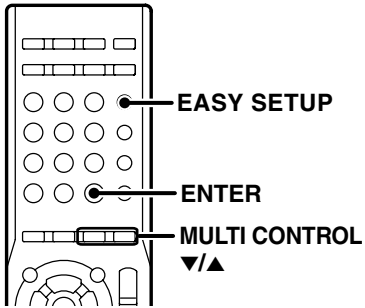

1 Press [EASY SETUP] to enter the easy setup mode.

2 Set the listening room size.

Use [MULTI CONTROL ▼/▲] to select your room type.



Reference for listening room size

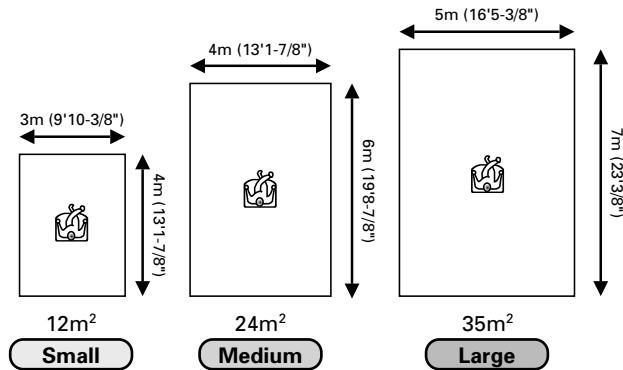

3 Select the listening position.

Use [MULTI CONTROL ▼/▲] to select your listening position.



Reference for listening position

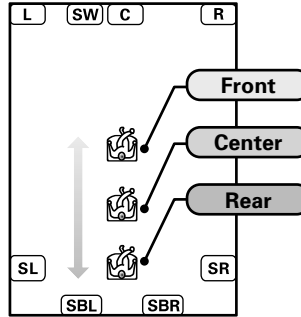

The speakers are set up as shown below.

Subwoofer :

➔ ON

Front speaker:

➔ "FRNT Normal" in <Speaker configuration – "SP Setup" –> of manual setup

Center speaker:

➔ "CNTR Normal" in <Speaker configuration – "SP Setup" –> of manual setup

Surround speaker:

➔ "SURR Normalx2" in <Speaker configuration – "SP Setup" –> of manual setup

Surround Back speaker:

➔ "SB Normal" in <Speaker configuration – "SP Setup" –> of manual setup

Subwoofer Re-mix :

➔ ON

For details on the setting contents, see <Speaker setup – "Manual Setup" –> → [36].



- Easy setup with may not be appropriate with certain speaker systems or listening environment. In this case, go through <Speaker setup – "Manual Setup" –> → [36].
- Easy setup can set only the 7.1 channel system. If the setup for the 5.1-channel or 6.1-channel system is required, go through <Speaker setup – "Manual Setup" –> → [36].

KRF-V9300D and KRF-V8300D Speaker setup – "Auto Setup"(Auto Room EQ)–

The Auto Room EQ function sets up the optimum home theater environment by automatically measuring and analyzing the following properties.

- Connected speakers
- Distance from each speaker to the listening position
- Size of each speaker
- Polarity of each speaker
- Reproduce frequency characteristic of each speaker
- Volume level of each speaker

This function uses the setup microphone provided with this unit.

The speakers output high-level test tones during measurement. Take special care for the neighborhood and sleeping children when using this function particularly in the nighttime.

Setup

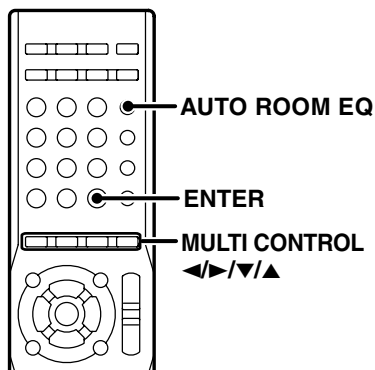

1 Connect the microphone to this unit.

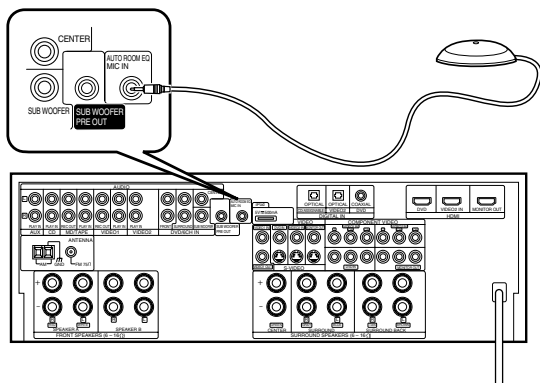

If headphones are plugged in, unplug them.

2 Place the microphone in the listening position.

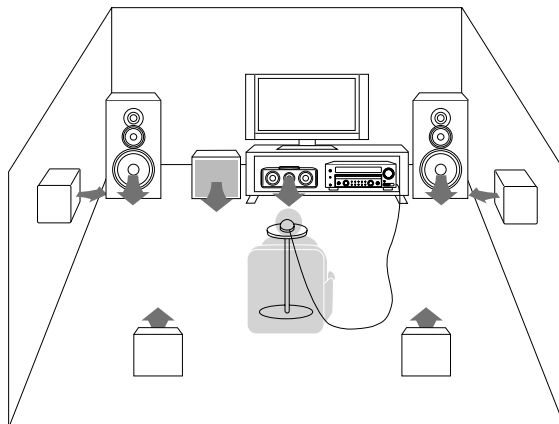

Place the microphone at the height of the listener's ears. Do not place any obstacle between the microphone and the speakers.

3 Enter the Auto Setup mode and start measurement.

[AUTO ROOM EQ]



Use [MULTI CONTROL ◀▶] to select "Calibrate".



Calibrate

[ENTER]



Use [MULTI CONTROL ◀▶] to select "Start".



Start

[ENTER]

Calibrating 1

It takes about 2 minutes before the measurement completes.

The display changes from "Calibrating 1" to "Calibrating 2". When the measurement completes, the display changes to "Analyzing", indicating that the measurement results are being analyzed. In this case, go to step 6.

If the measurement stopped in the middle and a message is displayed, go to step 4.

4 Check the message and take an action against the message.

See <If a message is displayed> → 34 and check the content of the message and follow the instructions.

5 Continue the measurement.

■ If a confirmation message (→ [35]) is displayed:
Use [MULTI CONTROL ▶] to select "Continue".



■ If an error message (→ [34]) is displayed:
Use [MULTI CONTROL ▶] to select "Retry".



6 Auto Setup completes.

The display changes from "Analyzing" to "Complete" when Auto Setup completes.



When "Confirm" is displayed, pressing the [ENTER] key makes it possible to confirm the measurement data. (See <To confirm the measurement data> → [33].)

Use [MULTI CONTROL ◀▶] to select "Return".

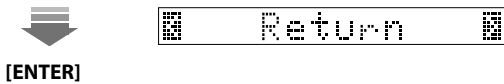

- Certain listening room properties may cause errors in the results of measurements of the speaker levels and distances. In this case, set up the unit again using "Manual Setup". (See <Speaker setup -"Manual Setup"-> → [36].)
- If the speakers or speaker placement have changed after auto setup, perform the auto setup again.

To confirm the measurement data

1 Select "Confirm" and press [ENTER] in step 3.

2 Use [MULTI CONTROL ◀▶] to select the item to be confirmed and press [ENTER]. And then use [MULTI CONTROL ◀▶] to confirm its data.

The following setting data can be confirmed.

- Speaker configuration ("SP Setup")
- Speaker levels ("SP Level")
- Speaker distances ("SP Distance")
- Crossover frequency ("Crossover")

For details on the setting items, see <Speaker setup -"Manual Setup"-> → [36].

To cancel measurement in the middle

Any of the following operations will stop the measurement in the middle and returns the display to the normal input display.

- Power ON/OFF
- Pressing the [AUTO ROOM EQ] key
- Press the [SETUP] key
- Pressing the [INPUT SELECTOR] key

If a message is displayed

If an error or a confirmation message is displayed and measurement is stopped in the middle, a trouble may be detected during the measurement. Read the message and take the proper measure before retrying measurement.

Error message: Take the measure according to the message and retry measurement.

Confirmation message: Check the message content. The operation can be continued without retrying measurement.

Error messages

"E1 : No Mic" :

The setup microphone is not connected.

- ➔ Connect the provided setup microphone to the [AUTO ROOM EQ MIC IN] jack.

"E2 : Phones" :

Headphones are connected.

- ➔ Unplug the headphones.

"E3 : No Sp L/R" / "E3 : No Sp L" :

One or both of the front speakers are not connected.

- ➔ Connect the front speakers properly.

"E3 : No Sp SL" / "E3 : No Sp SR" :

One of the surround speakers is not connected.

- ➔ Connect the surround speakers properly.

"E3 : No Sp SBL" :

One of the surround back speakers is not connected.

- ➔ If the system is a 7.1-channel system, connect both the surround back left and right speakers.
If it is a 6.1-channel system, connect the surround back speaker to the [SURROUND BACK L] terminal.

"E3 : SB w/o S" :

The surround left and right speakers are not connected.

- ➔ Connect the surround left and right speakers properly.

"E4 : Noisy" :

The measurement environment is too noisy.

- ➔ Remove the cause of noise before retrying measurement.

"E5 : Bad S/N" :

The measurement environment is too noisy.

- ➔ Retry measurement. Do not control the speaker volume during measurement.

"E6 : Far SP" :

The speaker is installed too apart.

- ➔ Reinstall the speaker.

"E7 : DSP" :

A communication error occurred inside the unit.

- ➔ Retry measurement. If the same error message reappears, contact your nearest Kenwood service counter.

"E8 : Time Out" :

The measurement took too long time due to a certain cause.

- ➔ Retry measurement. If the same error message reappears, contact your nearest Kenwood service counter.

Confirmation messages

"C1 : Phase L" / "C1 : Phase R" :

The +/- connection polarity of the front left or right speaker is inverted.

- ➔ Ensure that the front left or right speaker is connected with correct +/- polarity.

"C1 : Phase SL" / "C1 : Phase SR" :

The +/- connection polarity of the surround left or right speaker is inverted.

- ➔ Ensure that the surround left or right speaker is connected with correct +/- polarity.

"C1 : Phase SBL" / "C1 : Phase SBR" :

The +/- connection polarity of the surround back left or right speaker is inverted.

- ➔ Ensure that the surround back left or right speaker is connected with correct +/- polarity.

"C1 : Phase C" :

The +/- connection polarity of the center speaker is inverted.

- ➔ Ensure that the center speaker is connected with correct +/- polarity.

"C2 : No Sp C" :

The center speaker is not connected.

- ➔ Connect the center speaker if one is available. If it is not available, this message can be ignored.

"C2 : No Sp SW" :

The subwoofer is not connected.

- ➔ Connect the subwoofer if one is available. If it is not available, this message can be ignored.

"C2 : No Sp S" :

The surround speakers are not connected.

- ➔ Connect the surround speakers if they are available. If it is not available, this message can be ignored.

"C2 : No Sp SB" :

The surround back speakers are not connected.

- ➔ Connect the surround back speakers if they are available. If it is not available, this message can be ignored.

"C2 : No Sp SBR" :

The surround back right speaker is not connected.

- ➔ Connect the surround back right speaker if one is available. If it is not available, this message can be ignored.

Setting Room EQ

In addition to setting up the speakers, Auto Setup also measures the acoustic characteristics of the listening room and creates an equalizer curve matching them. "Room EQ" is used to select whether or not the equalizer curve is used.

1 Select "Room EQ".

[AUTO ROOM EQ]



Use [MULTI CONTROL ◀/▶] to select "Room EQ".



Room EQ

[ENTER]

2 Select whether the Room EQ curve is used or not.

Use [MULTI CONTROL ▼/▲] to select whether or not Room EQ is used.



Room EQ On

[ENTER]

Display	Setting
"Room EQ On"	The equalizer curve obtained with "Auto Setup" is used.
"Room EQ Off"	The equalizer curve obtained with "Auto Setup" is not used.



- The speaker setups made with Auto Setup are still active even after "Room EQ Off" is selected.

Speaker setup – "Manual Setup"–

Manual Setup is used to set up the speakers manually or to modify the setups made with Auto Setup.

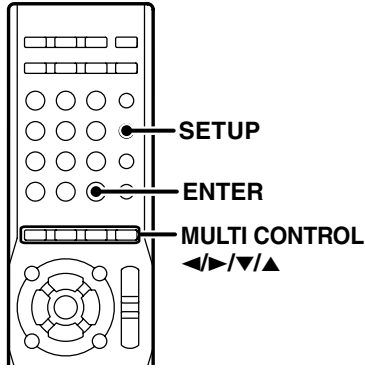

Setup

Speaker configuration – "SP Setup"–

Select the use of each speaker and its size.

1 Enter the Manual Setup mode.

[SETUP]



Use [MULTI CONTROL ◀▶] to select "Manual Setup".



Manual Setup

[ENTER]

2 Select "SP Setup".

[MULTI CONTROL ◀▶]



SP Setup

[ENTER]

3 Select the use and size of each speaker.

Use [MULTI CONTROL ◀▶] to select the speaker.



FRNT Large

Use [MULTI CONTROL ▼/▲] to set its use or size.

FRNT Normal

Repeat the above operations until all of the speakers have been set up.

Speaker	Display	Setting
Subwoofer	"SUBW On"	Subwoofer is connected.
	"SUBW Off"	Subwoofer is not connected.
Front speaker	"FRNT Large"	Large size front speaker
	"FRNT Normal"	Average size front speaker
Center speaker	"CNTR Large"	Large size center speaker
	"CNTR Normal"	Average size center speaker
	"CNTR Off"	Center speaker is not connected.
Surround speaker	"SURR Large"	Large size surround speaker
	"SURR Normal"	Average size surround speaker
	"SURR Off"	Surround speakers are not connected.

Surround Back speaker	"SB Largex2"	Large size surround back speakers (left and right) are connected. (7.1ch)
	"SB Largex1"	Large size surround back speaker (left only) is connected. (6.1ch)
	"SB Normalx2"	Average size surround back speakers (left and right) are connected. (7.1ch)
	"SB Normalx1"	Average size surround back speaker (left only) is connected. (6.1ch)
	"SB Off"	Surround back speakers are not connected.
	"Return"	Returns to Setup Menu.

4 Press [ENTER] to enter the setting.



- Reference for speaker size
 "Large": A speaker with a sufficient bass reproduction capability (a speaker with a large woofer or a large cabinet size).
 "Normal": A speaker with a lower bass reproduction capability than the "Large" speakers (the bass frequencies will be output from the speakers set to "Large" and the subwoofer).
 If you cannot identify the size of a speaker, it is recommended to set it to "Normal".
- When "SUBW Off" is selected, the front speakers are automatically set to "FRNT Large".
- For "FRNT Large" selection, no sound will be heard from subwoofer even it is set to ON. If you set the Subwoofer Remix to "On", you will be able to hear sound from the subwoofer. (See <Subwoofer Remix – "Subw Re-Mix" –> → (38))
- If "FRNT Normal" is selected, "Large" cannot be selected for the other speakers.
- If "SURR Off" is selected, no surround back speaker can be selected.
- If "SURR Normal" is selected for surround speakers, "SB Large" cannot be selected for the surround back speakers.

Speaker level – "SP Level"–

Adjust the volume levels of the speakers so that all of them are approximately identical.

1 Select "SP Level".

[SETUP]



[MULTI CONTROL ◀/▶]



SP Level

[ENTER]

2 Select the test tone output method.

[MULTI CONTROL ◀/▶]



T.TONE Auto

[ENTER]

Display	Setting
"T.TONE Auto"	The test tone is heard from the speakers one after another with 2 seconds each.
"T.TONE Manu"	You can select the speaker channel from which the test tone is output.
"T.TONE Off"	The speaker levels can be adjusted using the sound being played.
"Return"	Returns to Setup Menu.

3 Adjust the volume level of each speaker.

If you select "T.TONE Auto" :

When you hear the test tone from the speaker which you wish to adjust, use [MULTI CONTROL ▼/▲] and adjust the volume of the test tone. When you finish adjusting, press [ENTER].

If you select "T.TONE Manu" or "T.TONE Off" :

Use [MULTI CONTROL ◀/▶] to select the speaker channel to be adjusted, and then use [MULTI CONTROL ▼/▲] to adjust its volume level. After adjusting the levels of all the speaker channels, press [ENTER] to enter the settings.



- If you have a commercially available acoustic pressure meter, set the meter-reading unit to "C" and adjust the speaker channel levels so that the noise level is 75 dB. The adjustment should be performed in the listening position.

Speaker Distance – "SP Distance"–

Sets the distance between each speaker and the listening position. The actual distances should be measured before starting this setup.

Distances of speakers

Speaker	Input channel indicator	Distance from the listening position
Front speaker (left)	"L"	meters (feet)
Center speaker	"C"	meters (feet)
Front speaker (right)	"R"	meters (feet)
Surround speaker (right)	"SR"	meters (feet)
Surround Back speaker	"SB"	meters (feet)
Surround Back speaker (right)	"SBR"	meters (feet)
Surround Back speaker (left)	"SBL"	meters (feet)
Surround speaker (left)	"SL"	meters (feet)
Subwoofer	"SW"	meters (feet)

1 Select "SP Distance".

[SETUP]



[MULTI CONTROL ◀/▶]



SP Distance

[ENTER]

2 Select the unit of distance.

[MULTI CONTROL ◀/▶]



UNIT Meters

[ENTER]

Display	Setting
"UNIT Meters"	Measurement in meters.
"UNIT Feet"	Measurement in feet.
"Return"	Returns to Setup Menu.

3 Set the distance.

Refer to the table above for the distance from each speaker to this unit.

Use [MULTI CONTROL ◀/▶] to select the speaker.



LEFT 0.03m

Use [MULTI CONTROL ▼/▲] to set the distance.

LEFT 3.00m

The distance can be set in the range of 0.03 to 9.0 meters (0.1 to 30.0 ft) in 0.03-meter (0.1-foot) increments.

4 Repeat step 3 for each speaker until the distances of all speakers are set.

5 Press [ENTER] to enter the setting.

Subwoofer Remix – "Subw Re-Mix"–

Mixes the bass tone of other channels to the subwoofer channel.

1 Select "Subw Re-Mix".

[SETUP]



[MULTI CONTROL ◀/▶]



Subw Re-Mix

[ENTER]

2 Set the Subwoofer Remix.

Use [MULTI CONTROL ▼/▲] to select whether or not Subwoofer Remix is used.



SW RE-MIX On

[ENTER]

Display	Setting
"SW RE-MIX On"	Sets Subwoofer Remix to ON.
"SW RE-MIX Off"	Sets Subwoofer Remix to OFF. In this case, the bass frequencies are output only from the front speakers.



- Subwoofer Remix cannot be setup if the Subwoofer is set to "SUBW Off" or the Front speakers are set to "FRNT Normal".

Crossover – "Crossover"–

The crossover frequency is the lower limit of the bass frequencies reproduced from the speakers set to "Normal" in the <Speaker configuration –"SP Setup"–>. The frequencies below the set crossover frequency are output from other speakers (those set to "Large" and the subwoofer).

1 Select "Crossover".

[SETUP]



[MULTI CONTROL ◀/▶]



Crossover

[ENTER]

2 Set the crossover frequency.

Use [MULTI CONTROL ▼/▲] to select crossover frequency.



FREQ. 60Hz

[ENTER]

The frequency is selected from 40Hz to 200Hz in 10Hz step.

LFE (Low Frequency Effect) level – "LFE Level"–

Low frequency effect signal is used exclusively for giving the field effect of bass tone in the Dolby Digital and DTS signal.

1 Select "LFE Level".

[SETUP]



[MULTI CONTROL ◀/▶]



LFE Level

[ENTER]

2 Set the LFE level.

Use [MULTI CONTROL ▼/▲] to select the LFE level.



LFE LEVEL -3

[ENTER]

The level is adjusted from 0dB to -10dB in 1dB step decrements.

Input assignment – "Assignment"–

The input source for the signal output at the CD (ASSIGNABLE) terminal can be assigned: CD, VIDEO1 or AUX.

1 Select "Assignment".

[SETUP]



[MULTI CONTROL ◀▶]



Assignment

[ENTER]

2 Select the input source to be assigned.

Use [MULTI CONTROL ▼/▲] to select the input.



OPT1 CD

[ENTER]

Display	Setting
"OPT1 CD"	Assign CD as the input source
"OPT1 VIDEO1"	Assign VIDEO1 as the input source
"OPT1 AUX"	Assign AUX as the input source

Audio delay – "Audio Delay"–

If the monitored video is delayed in time with respect to the audio from the speakers, the audio output timing can be delayed.

1 Select "Audio Delay".

[SETUP]



[MULTI CONTROL ◀▶]



Audio Delay

[ENTER]

2 Set the delay time.

Use [MULTI CONTROL ▼/▲] to select the delay time.



DELAY 10ms

[ENTER]

The delay time is adjusted from 0ms to 300ms in 10ms step.

HDMI setup

The HDMI setup is required to use the component connected to the HDMI terminal or to use the HDMI control functions.

If you do not use the HDMI connection, disable the HDMI input setup. (See <HDMI input setup –"HDMI Input"–>.)

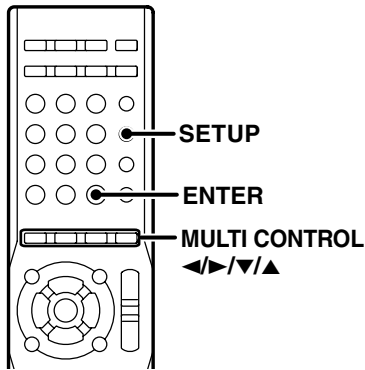

Setup

HDMI input setup –"HDMI Input"–

The HDMI inputs can be enable or disabled individually. Enabling an HDMI input makes it possible to set the HDMI function and use the HDMI control functions.

1 Select "HDMI Input".

[SETUP]



[MULTI CONTROL </>]



HDMI Input

[ENTER]

2 Select an HDMI input source (DVD or VIDEO2) and its HDMI audio and video inputs.

Use [MULTI CONTROL </>] to select the input source (DVD or VIDEO2).



DVD Video

Use [MULTI CONTROL </>] to set the HDMI audio and video inputs.



DVD A/V

[ENTER]

Display (When in DVD input source/ When in VIDEO2 source)	Setting
"DVD A/V" "VIDEO2 A/V"	Enables the HDMI inputs for both audio and video. Usually select this setting.
"DVD Video" "VIDEO2 Video"	Enables HDMI input only for video. The audio input becomes the digital (optical or coaxial) or analog audio input.
"DVD Off" "VIDEO2 Off"	The video input becomes the analog video input (VIDEO, S-VIDEO or COMPONENT VIDEO terminal) and the audio input becomes the digital (optical or coaxial) or analog audio input.

HDMI setup –"HDMI Setup"–

The HDMI control functions can be set.

1 Enter the HDMI Setup mode.

[SETUP]



Use [MULTI CONTROL </>] to select "HDMI Setup".



HDMI Setup

[ENTER]

2 Select an item to set.

[MULTI CONTROL </>]



Audio Out

[ENTER]

Display	Setting
"Audio Out"	Sets the HDMI audio output destination.
"Audio Delay"	Adjusts the deviation in time between the output audio and video.
"HDMI Link"	Sets whether or not the HDMI control functions are used.
"Power CTRL"*1	Interlocks power ON-OFF of components by means of HDMI control.
"TV CTRL"*2	Allows the TV to control this unit including the volume levels from the speakers.
"Return"	Returns to Setup Menu.

*1 This item can be set when "HDMI Link" is set to "On".

*2 This item can be set when "Power CTRL" is set to "On".

3 Set each item.

See next page for each HDMI control item.

Audio Out

This function selects whether the output destination of the audio input is the TV or this unit.

1 Select "Audio Out" in <HDMI setup –"HDMI Setup"> → .

2 Set the HDMI audio output destination.

[MULTI CONTROL ▼/▲]



AUDIO OUT AMP

[ENTER]

Display	Setting
"AUDIO OUT AMP"	Outputs the audio from the speakers connected to this unit.
"AUDIO OUT TV"	Outputs the audio from the TV connected to this unit.



- Audio Out can be set when TV Control is set to off.
- If "AUDIO OUT TV" is selected and the audio is not output or is interfered with by noise, set the audio output of the player component to PCM.
- If "AUDIO OUT TV" is selected, adjust the volume on TV.

Audio Delay (Lip Sync)

If the monitored video is delayed in time with respect to the audio from the speakers, the audio output timing can be delayed.

1 Select "Audio Delay" in <HDMI setup –"HDMI Setup"> → .

2 Set the HDMI audio delay.

[MULTI CONTROL ▼/▲]



DELAY Auto

[ENTER]

Display	Setting
"DELAY Auto"	Corrects the deviation in time between the output audio and video automatically.
"DELAY Manual"	Allows the user to correct the deviation in time between the output audio and video manually.
"DELAY Off"	The deviation in time between the output audio and video is not corrected.

When "DELAY Manual" is selected, use [MULTI CONTROL ▼/▲] to select the audio delay time and press [ENTER] to enter the setting.

The delay time is adjusted from 0ms to 300ms in 10ms step.



- If the TV in use is not compatible with "DELAY Auto", select "DELAY Manual".

HDMI Link

This function selects whether or not the volume control and input selection of this unit are interlocked with the operations of the connected components.

1 Select "HDMI Link" in <HDMI setup –"HDMI Setup"> → .

2 Set the HDMI link on or off.

[MULTI CONTROL ▼/▲]



HDMI LINK On

[ENTER]

Display	Setting
"HDMI LINK On"	The HDMI control functions are used.
"HDMI LINK Off"	The HDMI control functions are not used.

When "HDMI LINK On" is selected, the HDMI indicator on the front panel lights blue.

If "HDMI LINK On" is set, proceed to the <Power Control> setup.

Power Control

This function selects whether or not the power status of this unit is interlocked with the power ON/OFF and start of playback of the connected components.

1 Set the HDMI power control on or off.

[MULTI CONTROL ▼/▲]



POWER CTRL On

[ENTER]

Display	Setting
"POWER CTRL On"	Turning the TV ON/OFF also turns this unit ON/OFF with an interlocked operation.
"POWER CTRL Off"	The power ON/OFF status of this unit is not interlocked with the power ON/OFF status of the TV.

If "POWER CTRL On" is set, proceed to the <TV Control> setup.

TV Control

When this setup is "On", the TV can be used to control the functions (including the volume adjustment) of this unit.

1 Set the HDMI TV control on or off.

[MULTI CONTROL ▼/▲]



TV CTRL On

[ENTER]

Display	Setting
"TV CTRL On"	The TV can be used to control this unit.
"TV CTRL Off"	This unit cannot be controlled from the TV.



- The functions controllable from the TV are variable depending on the TV model. Refer to the instruction manual for your TV.

TV AUDIO IN – "TV Audio In"–

When the audio input of the TV is switched from the HDMI input (the signal from the HDMI monitor output of this unit) to the digital broadcasting (the built-in tuner of the TV) or other external input, this setup switches the input source of this unit to "OPT1" ([OPTICAL CD (ASSIGNABLE)] terminal) and allows the TV audio to be reproduced from the speakers connected to this unit. This makes it possible to enjoy digital surround audio broadcasting, etc. in the surround environment set with this unit.

1 Select "TV Audio In".

[SETUP]



[MULTI CONTROL ◀/▶]



TV Audio In

[ENTER]

2 Select an item to set.

[MULTI CONTROL ▼/▲]



TV AUDIO On

[ENTER]

Display	Setting
"TV AUDIO On"	The audio input can be switched automatically to output the TV audio from the speakers connected to this unit. (The input selector of this unit is also switched automatically to "OPT1").
"TV AUDIO Off"	The audio is not switched automatically (the input selector of this unit does not change).



- "TV Audio In" can be set when "HDMI Link" is on.

Locking the setups – "Setting Lock"–

The setups of this unit can be locked so that they will not be altered by accidental press of keys.

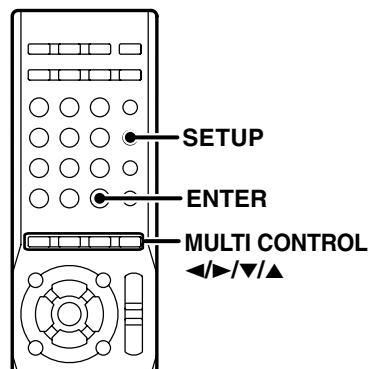

1 Select "Setting Lock".

[SETUP]



[MULTI CONTROL ◀/▶]



Setting Lock

[ENTER]

2 Lock the setup contents.

Use [MULTI CONTROL ▼/▲] to select "SETUP Locked".



SETUP Locked

[ENTER]

Display	Setting
"SETUP Locked"	Lock the setup contents.
"SETUP Unlocked"	Unlock the setup contents.

Confirming the HDMI function

Note that some HDMI control functions may not work with certain components and TV that are not compatible with them. To use the HDMI control functions properly, it is recommended to confirm the HDMI control functions usable with each connected component by performing the steps described below. If a function that is not available with a connected component is found, the related setup should be set to off before using this unit.

Before operation

- Check that this unit, the TV and the HDMI connection capable components are connected through HDMI cables.
- Check that the HDMI control of the TV and the HDMI-connectable components are enabled. (For the setups of the TV and player components, refer to their instruction manuals.)
- Enable the HDMI control of this unit
HDMI LINK: On, POWER CTRL: On, TV CTRL: On, TV AUDIO IN: On

Confirming the basic HDMI operations

- 1 Turn all of the HDMI-connected components ON.**
- 2 Switch the TV input to an input source connected through HDMI connection to this unit.**
- 3 Set the input selector of this unit to select the HDMI-connected input source and confirm that its video is displayed and the audio is output from the speakers properly.**

Confirming the HDMI control functions

- 1 Turn all of the HDMI-connected components ON.**
- 2 Adjusts the volume with the remote control unit of the TV.**

Is the volume of this unit adjusted accordingly? (HDMI Control confirmation)

- 3 Turn the TV OFF (standby) with its remote control unit.**

Are all of the components turned OFF? (Power Control confirmation)

- 4 With all of the HDMI-connected components OFF, start playing a player component.**

Are all of the components turned ON and the inputs of this unit and the TV switched automatically? (HDMI Link and Power Control confirmations)

- 5 If the TV has the audio output selector, switch the input selection and confirm that the appropriate audio is output.**

Is the appropriate audio output from this unit or the TV according to the audio input selection of the TV? (TV Control confirmation)

- If the TV does not have the audio output selector, set "TV CTRL" in the HDMI setup of this unit to "Off" and select the audio output destination in "Audio Out".
- If noise interferes with TV, set "Audio Out" to this unit or set the audio output of the TV and recorder/player component to PCM by referring to their instruction manuals.

- 6 Switch the TV input to the built-in tuner.**

Is the input to this unit switched automatically to "OPT1"? (TV Audio In confirmation)



- The HDMI control functions are not available during the following operations.
 - During speaker setup using test tone
 - During auto setup (KRF-V9300D and KRF-V8300D)
 - While the recording mode is set to on
 - During auto memory of radio stations

Preparation for playing music or movie

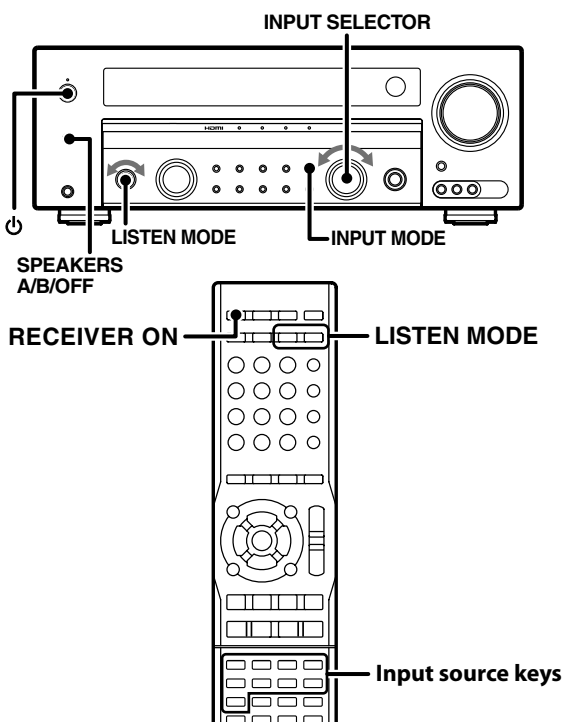

Turning on the power

- 1 Turn the connected monitor and player component ON.
- 2 Press [RECEIVER ON] (remote control unit) or [POWER] (main unit) to turn on the unit.

Setting the speaker system

- Operation available only on the main unit of this unit.

Press [SPEAKERS A/B/OFF] to select the speaker system(s) to be used.

The speaker system(s) to be used light up.

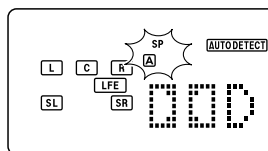

- Speaker system B cannot be selected when the input mode is "6ch Input".

Selecting the input mode

- Operation available only on the main unit of this unit.

When playing a component connected to the digital input terminal (CD(ASSIGNABLE), VIDEO2 or DVD) or the HDMI input terminal (DVD IN or VIDEO2 IN), set the input mode to match the type of the audio input.

- 1 Use [INPUT SELECTOR] to select "CD" (or "VIDEO 1" or "AUX" which you assigned to CD(ASSIGNABLE) terminal), "VIDEO2" or "DVD" input source.
- 2 Press [INPUT MODE] to select the input mode.

Each press switches the mode as follows.

When the HDMI input is disabled:

Display	Setting
"Full Auto"	The digital and analog inputs are switched automatically according to the input signal. When a digital input is detected, the decode mode is also switched according to the signal type (PCM/Dolby Digital/DTS).
"Digital Manual"	The input mode is fixed at digital to accelerate the input signal processing and eliminate lack of audio at the beginning of playback. The decode mode is also fixed according to the type of the signal to be played.
"6ch Input" ^{*1*2}	The analog 6-channel input mode to be selected when playing the DVD player connected to the DVD/6CH IN terminal.
"Analog" ^{*2}	The input mode is fixed at analog. This is selected for playback of analog player components.

*1 "6ch Input" setting can be selected only when the input selector is set to "DVD (6ch In)".

*2 This cannot be selected when in DTS play mode.

**When the HDMI input is enabled:
(Input source is set to "DVD" or "VIDEO2" only)**

Display	Setting
"Signal Auto"	The decode mode is switched automatically according to the digital signal type (PCM/Dolby Digital/DTS).
"Signal Manual"	The decode mode is fixed according to the type of the digital signal to be played.



- The AUTO DETECT indicator lights when "Full Auto" or "Signal Auto" is selected.

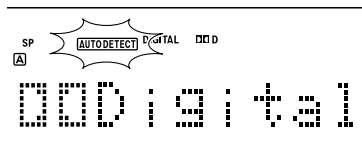

- If the audio is lost as a result of change in the input signal while "Digital Manual" is selected, press [LISTEN MODE].

Playback

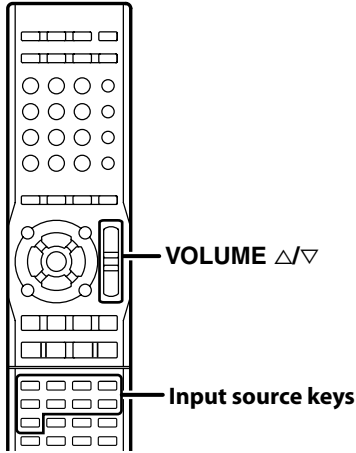
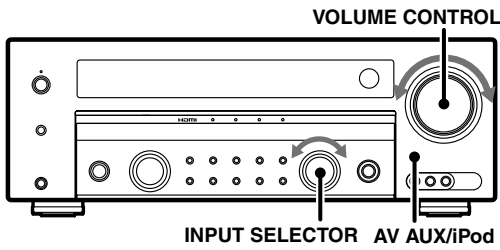

1 Select the source.

Use the Input source keys on the remote control unit to select a source.
Or use [INPUT SELECTOR] knob or [AV AUX/iPod] key on the main unit.

2 Start playback from the selected source.

The iPod can be controlled from this unit. (See <iPod control> → [48].)

3 Use [VOLUME Δ/▽] to adjust the volume.

4 Enjoy various surround effects.

You can enjoy a variety of listen modes. (See <Surround play using the listen mode> → [51].)
The surround effects can be fine tuned according to the selected input source. (See <Adjustments according to the playing source> → [62].)



- The AV AUX and iPod inputs cannot be selected with the [INPUT SELECTOR] knob of this unit. These inputs should be selected using the [AV AUX/iPod] on this unit or the [AV AUX] or [iPod] key on the remote control unit.

Monitoring the input source in the original sound (STRAIGHT DECODE mode)

The signal input from a source can be output directly without any sound field effect added to it.

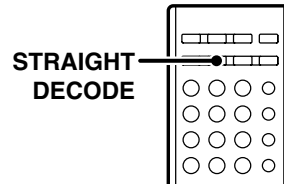
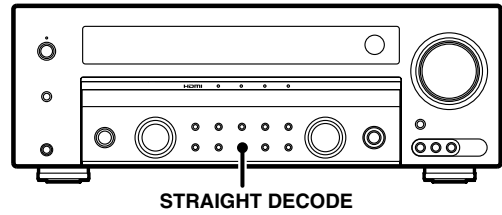

- Select the source.
- Start playback from the selected source.
- Press [STRAIGHT DECODE].

When STRAIGHT DECODE mode is enabled, the listen mode is selected automatically according to the input signal. (See <Input signals and corresponding listen modes> → [52].)

"STRAIGHT" indicator lights up.

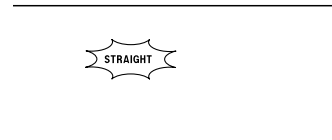

To cancel

Press [STRAIGHT DECODE].

STRAIGHT DECODE mode is also canceled when [LISTEN MODE] is operated.



- When the input mode is "6ch Input", the listen mode does not change. (<Selecting the input mode> → [44].)
- If the input signal uses a number of channels larger than the number of speakers in use, the signals are distributed automatically according to the available speakers.

Listening to music with PURE AUDIO MODE

PURE AUDIO MODE turns the display and analog video circuitry (other than HDMI) off to eliminate their effects on the audio circuitry. This mode thereby makes it possible to enjoy audio with higher quality and higher fidelity to the original sound.

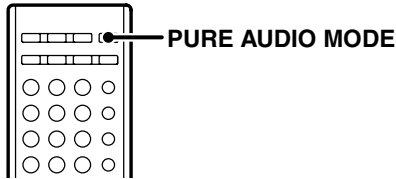
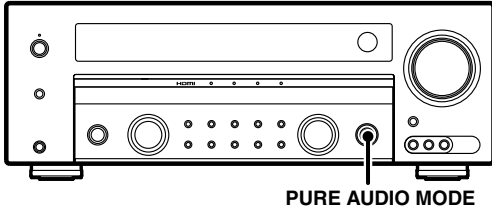

- When the input mode is "6ch Input", the listen mode does not change. (<Selecting the input mode> → [44](#))
- The video other than the HDMI input video cannot be monitored when PURE AUDIO MODE is selected.
- KRF-V9300D only
The video from the VIDEO, S-VIDEO or COMPONENT VIDEO signal input cannot be monitored even if it is converted for the HDMI output.

Playing music or movie

- 1** Select the music source you want to listen to.
- 2** Start playback from the selected source.
- 3** Press [PURE AUDIO MODE].

When PURE AUDIO MODE is enabled, the listen mode is selected automatically according to the input signal. (See <Input signals and corresponding listen modes> → [52](#).)

"PURE AUDIO MODE" indicator lights up, the display will be turned off, and no video signal is output to the TV monitor.

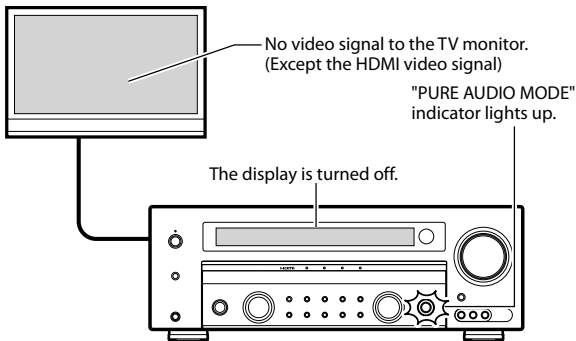

To cancel

Press [PURE AUDIO MODE].

PURE AUDIO MODE is also canceled when the [LISTEN MODE] or [STRAIGHT DECODE] key is operated.

KRF-V9300D

Switching the video resolution

- Operation available only on the remote control unit.

Press to select the resolution of the HDMI video output as a result of conversion of an analog video signal.

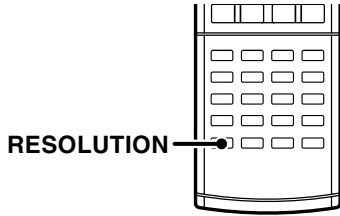

1 Press [RESOLUTION] to select the resolution.

Each press switches the setting as follows.

Display	Setting
"RES Auto"	The resolution is set automatically according to the connected TV monitor.
"RES 1080p"	1920 x 1080p
"RES 720p"	1280 x 720p
"RES 1080i"	1920 x 1080i
"RES 480p/576p"	720 x 480p, 720 x 576p



- The available resolution values vary depending on the connected TV monitor.

Checking the HDMI audio input signal which output from the connected component

- Operation available only on the remote control unit.

The type and number of channels of the audio signal input at the HDMI input can be checked.

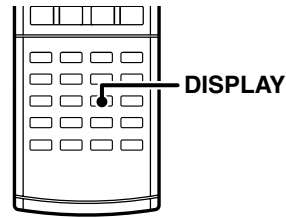

1 Press [DISPLAY].

The type and number of channels of the HDMI input signal are displayed for a few seconds.

Example: Display with DTS-HD Master Audio 5.1-channel input

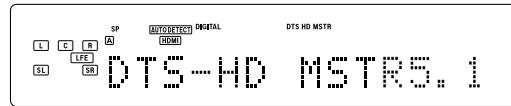

- There are some video contents which have more audio signals recorded than the input channel indicator on this unit are shown. This is because at the recording studio the audio sometime is produced with a different speaker configuration from the standard speaker configuration. In this case, the input channel indicator only shows the channels which are the same as the standard speaker configuration, and display shows the total number of channels recorded in the video contents. Example: Total number of channels is 7.1ch and the input channel indicator is showing 5.1ch

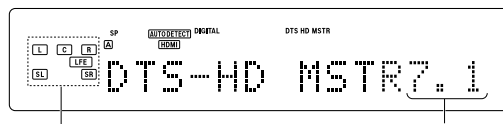

Input channel indicator

Total number of channels

- Even in the case above, the optimum playback is performed according to the speaker setup (speaker re-mapping function).

iPod control

When an iPod is connected to the iPod terminal of this unit using PNC-iP120 (optional), the iPod can be controlled from this unit.

Preparations

- **Video compatible iPod only**
Set the "TV OUT" of the iPod to "ON".
Set the "TV Signal" of the iPod to "PAL".
- **Using the PNC-iP120 (optional), connect the iPod to the iPod terminal on the rear panel of this unit.**
Be sure to turn this unit OFF (standby) before proceeding to the connection.
- **Turn this unit ON.**

Using the menus

Playing music or movie

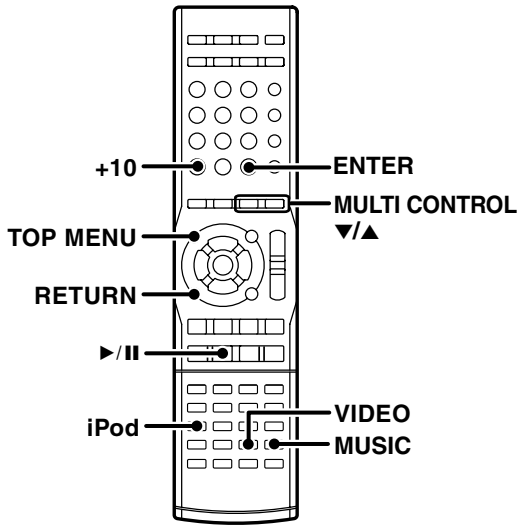

- 1 Press [iPod] to set the input source to iPod.
- 2 Press [TOP MENU] to enter the menu mode.
If the iPod in use is not video compatible, go to step 5 now.
- 3 **Video compatible iPod only**
Use [MULTI CONTROL ▼/▲] to select menu category ("VIDEO" or "MUSIC").
- 4 Press [ENTER].
- 5 Use [MULTI CONTROL ▼/▲] to select an item.
- 6 Press [ENTER].
- 7 Repeat the step 5 and 6 until you reach the track (file) you want to play.

If a menu in level 3 or below has a large number of items, pressing the [+10] key makes it possible to skip 10 items at a time.

After selecting the track, press [ENTER] or [▶/||] key to start its playback.

To select a menu in a different category (Video compatible iPod only)

Press [MUSIC] or [VIDEO] on the remote control unit.

To return to the higher level in the hierarchy

Press [RETURN] on the remote control unit.



- Pressing the [▶/||] key after selecting a playlist, an album, an artist or a genre, etc. will play all the tracks in the selected item.
- For the iPod models usable with this unit, see <iPod models usable with this unit> -> .
- "No Data" is displayed if there is no data in the selected menu item.
- While the iPod is connected to this unit, the iPod can be controlled from this unit or the remote control unit provided with it. When the iPod is connected to this unit, it cannot be used to control its operations.
- The items in the menu and its order may vary depending on the iPod models.

Menu example

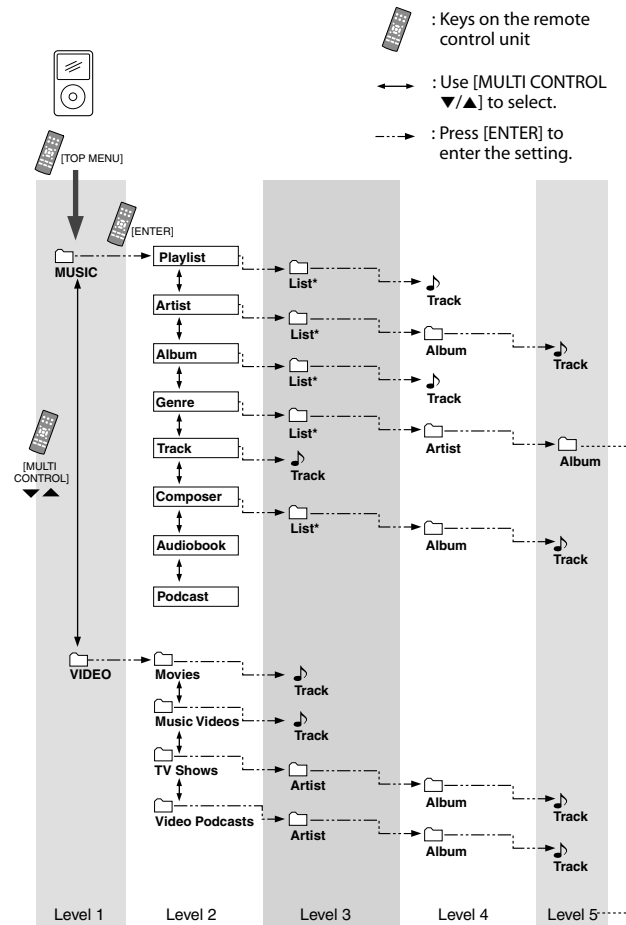

* List : List of selected items

iPod operation

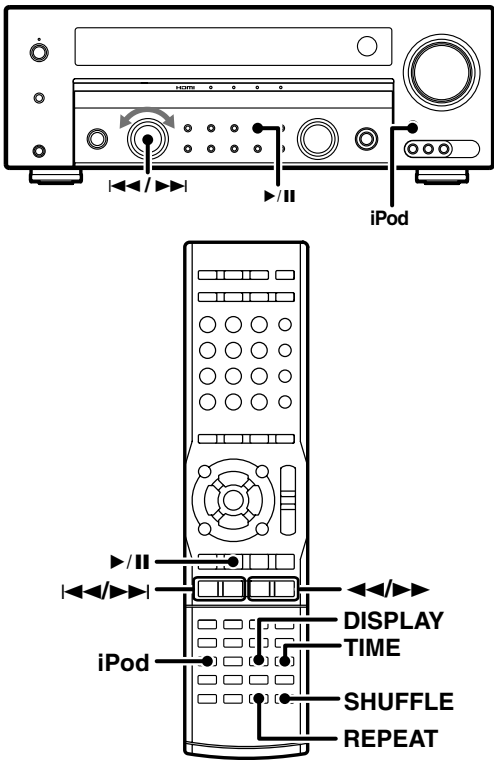

Play and pause

Press **[▶/II]**.

Pressing **[▶/II]** during play will pause the play. Pressing it again will cancel pausing.

The name of the currently playing file is displayed.

File skip

Press **[◀◀]** or **[▶▶]**.

If **[◀◀]** is pressed in the middle of playback, the playing file will be replayed from the beginning.

Fast forward and backward

● Operation available only on the remote control unit.

Press **[◀◀]** or **[▶▶]**.

Keep pressing the key until you reach the desired point. Play starts when the key is released.

The information selected in <Switching the time information> is displayed.

Repeat play

● Operation available only on the remote control unit.

Press **[REPEAT]**.

Each press switches the mode as follows:

Display	Mode
"Repeat One"	Single track (file) repeat
"Repeat All"	All tracks (files) repeat
"Repeat Off"	Repeat play is cancelled.

Shuffle play

● Operation available only on the remote control unit.

Press **[SHUFFLE]**.

Each press switches the mode as follows:

Display	Mode
"Shuffle Track"	Plays tracks (files) in a random order.
"Shuffle Album"	Plays albums in a random order.
"Shuffle Off"	Disables the shuffle play.

Switching the display

● Operation available only on the remote control unit.

The displayed text information can be switched as follows.

Press **[DISPLAY]** during play or pause.

Each press switches the information as follows:

Information
Track name (file name)
Album name
Artist name

The selected information is scrolled on the display.



• For the displayable characters on this unit, see <iPod models usable with this unit> →

Switching the time information

● Operation available only on the remote control unit.

The displayed time information can be switched as follows.

Press **[TIME]** during play or pause.

Each press switches the information as follows:

Information
File number and elapsed time of the current file
File number and remaining time of the current file
File number of the current file / Total file number of the selected item

Listen mode

The listen modes provided with this unit allow you to enjoy various surround effects with various video software. To enjoy the surround audio in the best condition, it is required to set up the speakers in advance.

5.1 ch surround sound system

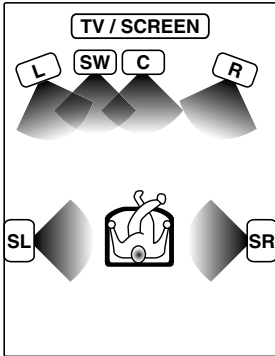

7.1 ch surround sound system

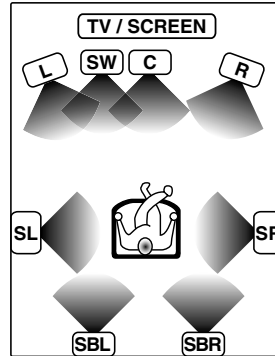

6.1 ch surround sound system

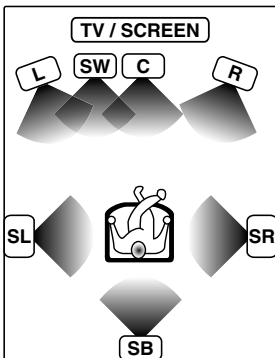

- L: Front Left speaker
- SW: Subwoofer
- C: Center speaker
- R: Front Right speaker
- SL: Surround Left speaker
- SR: Surround Right speaker
- SB: Surround Back speaker
- SBL: Surround Back Left speaker
- SBR: Surround Back Right speaker

Surround effects

About indicators

Listen mode/Input signal format indicators

The indicator for the selected listen mode lights up.

The "DIGITAL" indicator also lights up when the input is a digital signal.

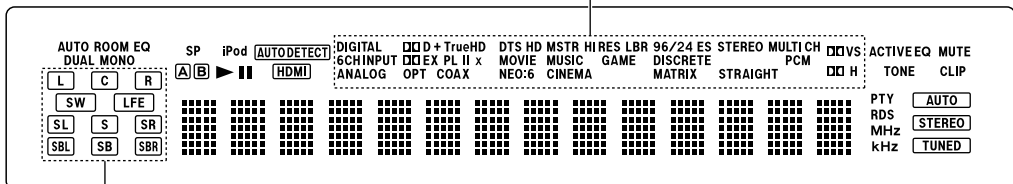

Input channel indicators

These indicators show the input channels used with the playing music and video.

- These indicators do not show the channels selected in the current listen mode.

The "LFE" indicator lights when the LFE channel signal is input. The LFE level can be adjusted. (See <LFE (Low Frequency Effect) level - "LFE Level" -> → [38].)

The "S" indicator lights when the surround signal consists of a single channel.

Surround play using the listen mode

Select the listen mode according to the source being played back.

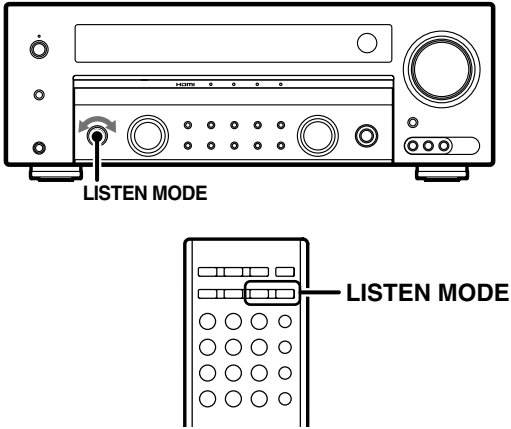

Preparations

- Turn the components to be used ON.
- Complete <Speaker setup>.
- Select the source you wish to play back with surround sound.
- Select the input mode → [44].
(When the input mode is set to "Full Auto" or "Signal Auto" (i.e. when the "AUTO DETECT" indicator is lit), the listen mode matching the input signal type and speaker setups is selected automatically. Noise may be produced when a DTS source is played by selecting the analog input.)

- 1** Start playing the selected source.
- 2** Use [LISTEN MODE] to select the listen mode.

Each press switches the listen mode.

For the types of listen modes, see <Input signals and corresponding listen modes> → [52].

Input signals and corresponding listen modes

Dolby Digital, Dolby Digital EX, Dolby Digital Plus and Dolby TrueHD source

Connected audio input jack	HDMI, OPTICAL, COAXIAL			HDMI								
	Dolby Digital / Dolby Digital EX			Dolby Digital Plus				Dolby TrueHD (96kHz and lower)				Dolby TrueHD (176.4kHz/ 192kHz)
	*/2	2ch	Others	*/2	*/3 */4	2ch	Others	*/2	*/3 */4	2ch	Others	
Dolby Digital	<input type="radio"/>	<input type="radio"/>	<input type="radio"/>									
Dolby Digital + Pro Logic IIx Movie*1	<input type="radio"/>											
Dolby Digital + Pro Logic IIx Music*3	<input type="radio"/>											
Dolby Digital EX*3	<input type="radio"/>											
Dolby Digital Plus				<input type="radio"/>	<input type="radio"/>	<input type="radio"/>	<input type="radio"/>					
Dolby Digital Plus + Pro Logic IIx Movie*1				<input type="radio"/>								
Dolby Digital Plus + Pro Logic IIx Music*3				<input type="radio"/>								
Dolby Digital Plus + Dolby EX*3				<input type="radio"/>								
Dolby TrueHD								<input type="radio"/>	<input type="radio"/>	<input type="radio"/>	<input type="radio"/>	<input type="radio"/>
Dolby TrueHD + Pro Logic IIx Movie*1								<input type="radio"/>				
Dolby TrueHD + Pro Logic IIx Music*3								<input type="radio"/>				
Dolby TrueHD + Dolby EX*3								<input type="radio"/>				
Pro Logic IIx Movie/ Pro Logic II Movie*2		<input type="radio"/>				<input type="radio"/>				<input type="radio"/>		
Pro Logic IIx Music/ Pro Logic II Music*2		<input type="radio"/>				<input type="radio"/>				<input type="radio"/>		
Pro Logic IIx Game/ Pro Logic II Game*2		<input type="radio"/>				<input type="radio"/>				<input type="radio"/>		
Pro Logic		<input type="radio"/>				<input type="radio"/>				<input type="radio"/>		
Stereo	<input type="radio"/>	<input type="radio"/>	<input type="radio"/>	<input type="radio"/>	<input type="radio"/>	<input type="radio"/>	<input type="radio"/>	<input type="radio"/>	<input type="radio"/>	<input type="radio"/>	<input type="radio"/>	<input type="radio"/>

*1 Can be selected only when both the surround back left and right speakers are connected (7.1-channels).

*2 Pro Logic II is selected if no surround back speakers are connected.

*3 Can be selected when one or more surround back speakers are connected.

- Certain listen modes may not be selected depending on the input signal type and speaker setup.
- If the surround effect cannot be obtained or the desirable listen mode cannot be selected, check the following setups.
 - Speaker setup
 - Input mode setup
 - Audio setup of the player component
- When a digital signal with a number of channels exceeding the current speaker setup is input, the input signal is downmixed automatically according to the current speaker setup.

Note on input signals

"*/2" or "*/3", etc, in the table under <Input signals and corresponding listen modes> indicate the channels encoded in the input signal. When an encoded signal is input, the input channel indicators on the display panel light as follows.

*2: L, C, R, SL, SR or L, R, SL, SR

*3: L, C, R, SL, SR, SB or L, R, SL, SR, SB

*4: L, C, R, SL, SR, SBL, SBR or L, R, SL, SR, SBL, SBR

2ch: L, R

Others: Dual Mono (L, R), 3/0 (L, C, R), 3/1 (L, C, R, S)

• For "LFE" and "S" input channel indicators, see <About indicators> → [50](#).

DTS, DTS 96/24 and DTS-ES source

Connected audio input jack		HDMI, OPTICAL, COAXIAL								
Input signal		DTS			DTS 96/24			DTS 96/24 ES Matrix	DTS-ES Discrete	DTS-ES Matrix
		*2	2ch	Others	*2	2ch	Others	*2	*3	*2
Listen mode										
DTS		<input type="radio"/>	<input type="radio"/>	<input type="radio"/>					<input type="radio"/>	<input type="radio"/>
DTS + Neo:6 ^{*3}		<input type="radio"/>								
DTS-ES Discrete ^{*3}									<input type="radio"/>	
DTS-ES Matrix ^{*3}										<input type="radio"/>
DTS 96/24					<input type="radio"/>	<input type="radio"/>	<input type="radio"/>	<input type="radio"/>		
DTS 96/24 + Neo:6 ^{*3}					<input type="radio"/>					
DTS 96/24 ES Matrix ^{*3}								<input type="radio"/>		
Neo:6 Cinema			<input type="radio"/>			<input type="radio"/>				
Neo:6 Music			<input type="radio"/>			<input type="radio"/>				
Stereo		<input type="radio"/>	<input type="radio"/>	<input type="radio"/>	<input type="radio"/>	<input type="radio"/>	<input type="radio"/>	<input type="radio"/>	<input type="radio"/>	<input type="radio"/>

*3 Can be selected when one or more surround back speakers are connected.

DTS-HD Master Audio, DTS-HD High Resolution Audio and DTS-HD Low Bit Rate Audio source

Connected audio input jack		HDMI												
Input signal		DTS-HD Master Audio (96kHz and lower)				DTS-HD Master Audio (176.4kHz/192kHz)	DTS-HD High Resolution Audio				DTS-HD Low Bit Rate Audio			
		*2	*3 */4	2ch	Others		*2	*3 */4	2ch	Others	*2	*3 */4	2ch	Others
Listen mode														
DTS-HD Master Audio		<input type="radio"/>	<input type="radio"/>	<input type="radio"/>	<input type="radio"/>	<input type="radio"/>								
DTS-HD Maser Audio + Neo:6 ^{*3}		<input type="radio"/>												
DTS-HD High Resolution Audio							<input type="radio"/>	<input type="radio"/>	<input type="radio"/>	<input type="radio"/>				
DTS-HD High Resolution Audio + Neo:6 ^{*3}							<input type="radio"/>							
DTS-HD Low Bit Rate											<input type="radio"/>	<input type="radio"/>	<input type="radio"/>	<input type="radio"/>
DTS-HD Low Bit Rate + Neo:6 ^{*3}											<input type="radio"/>			
Neo:6 Cinema				<input type="radio"/>							<input type="radio"/>		<input type="radio"/>	
Neo:6 Music				<input type="radio"/>							<input type="radio"/>		<input type="radio"/>	
Stereo		<input type="radio"/>	<input type="radio"/>	<input type="radio"/>	<input type="radio"/>	<input type="radio"/>	<input type="radio"/>	<input type="radio"/>	<input type="radio"/>	<input type="radio"/>	<input type="radio"/>	<input type="radio"/>	<input type="radio"/>	<input type="radio"/>

*3 Can be selected when one or more surround back speakers are connected.

PCM and analog source

Connected audio input jack	HDMI		HDMI, OPTICAL, COAXIAL	HDMI	AUDIO PLAY IN
Input signal Listen mode	PCM				Analog
	*/2	*/3 */4	2ch		
			96kHz and lower	Over 96kHz	
Pro Logic IIx Movie/ Pro Logic II Movie*2			<input type="radio"/>		<input type="radio"/>
Pro Logic IIx Music/ Pro Logic II Music*2			<input type="radio"/>		<input type="radio"/>
Pro Logic IIx Game/ Pro Logic II Game*2			<input type="radio"/>		<input type="radio"/>
Pro Logic			<input type="radio"/>		<input type="radio"/>
Neo:6 Cinema			<input type="radio"/>		<input type="radio"/>
Neo:6 Music			<input type="radio"/>		<input type="radio"/>
PCM	<input type="radio"/>	<input type="radio"/>			
Stereo	<input type="radio"/> *4	<input type="radio"/> *4	<input type="radio"/>	<input type="radio"/>	<input type="radio"/>

*2 Pro Logic II is selected if no surround back speakers are connected.

*4 Cannot be selected depending on the DVD-Audio content.

KRF-V9300D and KRF-V8300D Virtual mode

These modes allow you to enjoy surround sound even when you use headphones or you connect only the front speakers.

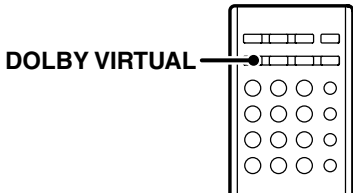
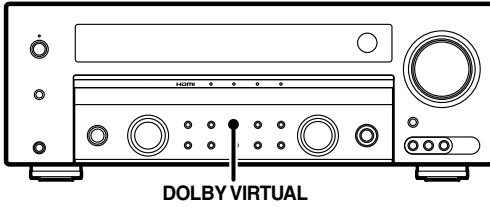

1 Press [DOLBY VIRTUAL].

Each press switches the setting as follows:

Dolby Virtual Speaker mode (When not using headphones)

Display	Setting
"Dolby VS Wide"	Provides the virtual surround effect with a wider expansion and spatial feeling.
"Dolby VS Ref"**	Provides the virtual surround effect. This is the standard setting.
"Dolby VS Off"	Sets the Dolby Virtual Speaker mode to off.

* This can be selected when the surround speaker setup is set to off.

Dolby Headphone mode (When using headphones)

Display	Setting
"Dolby H On"	Sets the Dolby Headphone mode to on. Provides the virtual surround effect.
"Dolby H Off"	Sets the Dolby Headphone mode to off.



- In the virtual modes, certain listen modes cannot be selected depending on the reproduced signal.
- The virtual modes are set to off when the sampling frequency is either 176.4 kHz or 196 kHz.

DVD 6 channel analog input

Surround play is possible if you use a DVD player with 6- (5.1-) channel output.

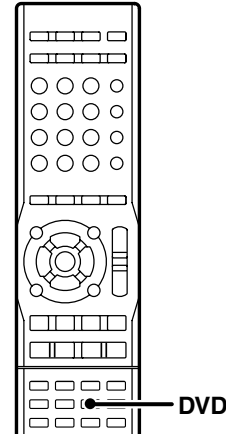
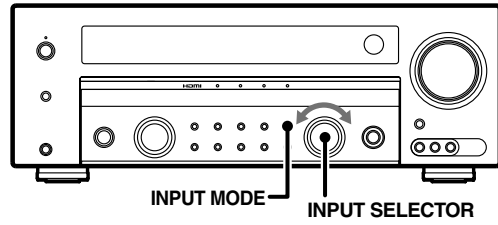

Preparations

- Connect your DVD player to the [DVD/6CH IN] terminals of this unit.
- Turn the components to be used ON.

1 Set the input source to "DVD".

2 Press [INPUT MODE] and select "DVD (6ch IN)" input mode.

3 Play the DVD.



- It is not possible to adjust the speaker level or sound effect of the channels separately when this unit is in the 6ch Input mode. ([EASY SETUP] (KRF-V7300D), [SETUP], [SOUND], [LISTEN MODE], [ACTIVE EQ] and [TONE] will not be functional.) Adjust the speaker level with the controls of the DVD player. Refer to the Instruction manual of the DVD players for the detailed operating instructions.
- DVD 6-channel play is not available when "DVD A/V" is selected in the HDMI input setup. (See <HDMI input setup - "HDMI Input" -> → [40].)

Tuning into a radio station

This unit can store up to 40 stations in the memory and recall them by one-touch operation.

Radio stations can be classified into RDS (Radio Data System) stations and other stations. To listen to or store RDS stations in the preset memory see <Using RDS (Radio Data System)>.

Be sure to connect antennas to receive radio broadcasts. (See <Connecting antennas> → [28].)

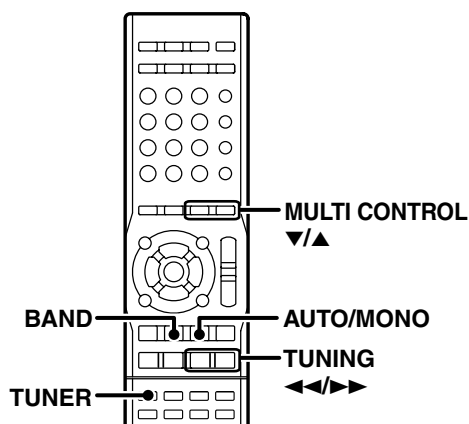
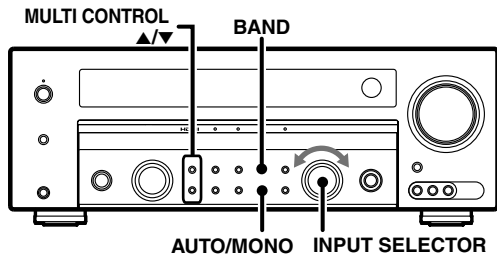

Listening to radio broadcasts

- 1 Set the input source to TUNER.
- 2 Use [BAND] to select the broadcast band.
Each press switches the band as follows:
① FM
② AM
- 3 Use [AUTO/MONO] to select the tuning method.
Each press switches the tuning method as follows:

Setting	Operation	Indicator
Auto tuning	The next station is tuned automatically.	"AUTO" lit
Manual tuning	Select a station manually.	"AUTO" not lit



Normally, set to "AUTO" (auto tuning). If the radio waves are weak and there is a lot of interference, switch to manual tuning. (With manual tuning, stereo broadcasts will be received in monaural.)

- 4 Use [TUNING <</>] to select the station.

"TUNED" lights when a broadcast is being received.

"STEREO" lights when a broadcast is being received in stereo.



- [MULTI CONTROL ▼/▲] can also be used to select a station.

Using RDS (Radio Data System)

RDS is a system that transmits useful information (in the form of digital data) for FM broadcasts along with the broadcast signal. Tuners and receivers designed for RDS reception can extract the information from the broadcast signal for use with various functions, such as automatic display of the station name.

Before using a function utilizing the RDS, be sure to perform the RDS Auto Memory operation by referring to the description in <RDS Auto Memory> → [57].

RDS functions:

RDS AUTO MEMORY function

Automatically selects and stores up to 40 RDS stations in the preset memory. If fewer than 40 RDS stations have been stored in the preset memory, regular FM stations will be stored in the remaining places.

PS (Program Service) Name Display

Automatically displays the station name transmitted by the RDS station.

PTY (Program Type) identification Search

Automatically tunes to a station that is currently broadcasting the specified program type (genre).

RT (Radio Text) function

Displays the radio text data transmitted by some RDS stations when you press [DISPLAY]. There is "No RT" or "RT ----" display if no text data is transmitted.

The "RDS" indicator lights up when an RDS broadcast (signal) is received.



- Some functions and function names may differ for certain countries and areas.

RDS Auto Memory

This function automatically stores up to 40 RDS stations in the preset memory. In order to use the PTY function, the RDS stations must be stored in the preset memory using the RDS AUTO MEMORY function.

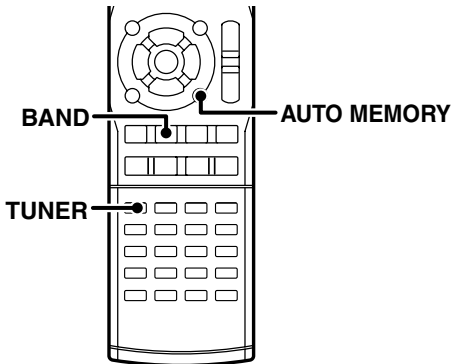

- 1** Press [TUNER] to select the tuner.
- 2** Press [BAND] to set the broadcast band to "FM".
- 3** Press [AUTO MEMORY] to start auto memory.

Auto Memory

After a few minutes, up to 40 RDS stations are preset in order from channel "01".

Stations already stored in the preset memory may be replaced by RDS stations. (i.e., If the RDS AUTO MEMORY function detects 15 RDS stations, the stations currently preset at numbers 01-15 will be replaced by the RDS stations.)

Presetting radio stations manually

The RDS auto memory function assigns preset numbers to RDS stations starting from preset number "1". Therefore, be sure to execute the RDS auto memory function before using the following operations to manually store AM stations and other FM stations, and RDS stations.
See <RDS Auto Memory>.

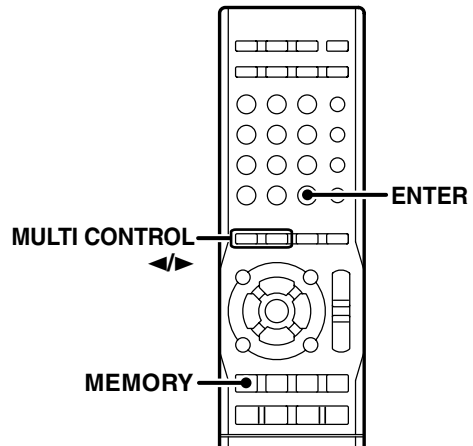

- 1** Tune in the station you want to store.
- 2** Press [MEMORY] while receiving the station.

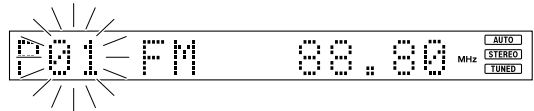

Proceed to step 3 within 20 seconds.

If more than 20 seconds elapse, press [MEMORY] again.

- 3** Use [MULTI CONTROL ◀/▶] to select one of the station presets (1 - 40).
- 4** Press [ENTER] to confirm the setting.

Repeat steps 1 to 4 to store as many stations as necessary.

If you store a station at a previously used preset, the previous station will be replaced by the new one.

Receiving preset stations

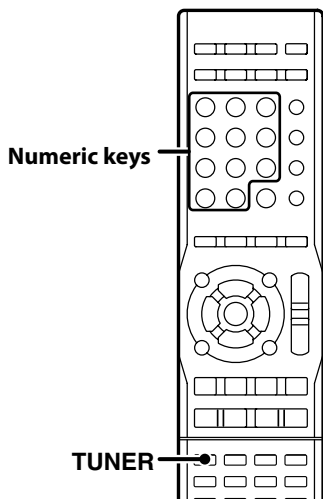

- 1 Press [TUNER] to select tuner as the source.
- 2 Enter the number of the preset station you want to receive (up to "40" preset numbers).

Press the Numeric keys in the following order:

For preset No.15: [+10] and [5]

For preset No.20: [+10], [+10] and [0]



Preset number



- If you make a mistake entering a two digit number, press [+10] repeatedly to return to the original display and start again.

Receiving preset stations in order (P.CALL)

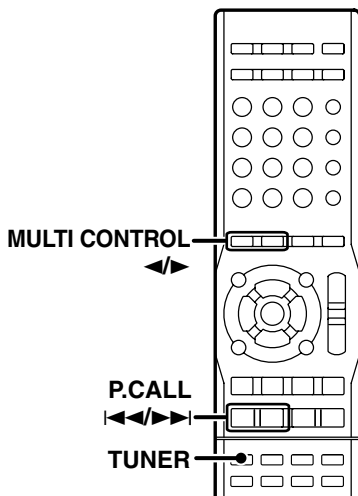

- 1 Press [TUNER] to select tuner as the source.

- 2 Use [P.CALL <◀▶>] to select the desired station.

Each time you press the key, another preset station is received in order.

Holding down the [P.CALL <◀▶>] lets you skip through the presets, receiving each preset station at 0.5 second intervals.



- [MULTI CONTROL <◀▶>] can also be used to select the preset station.

Tuning by program type (PTY search)

This function lets you set the tuner to automatically search for stations which are currently broadcasting the type of program (genre) you want to listen to.

Under certain receiving conditions, it may take more than 1 minute to complete the search.

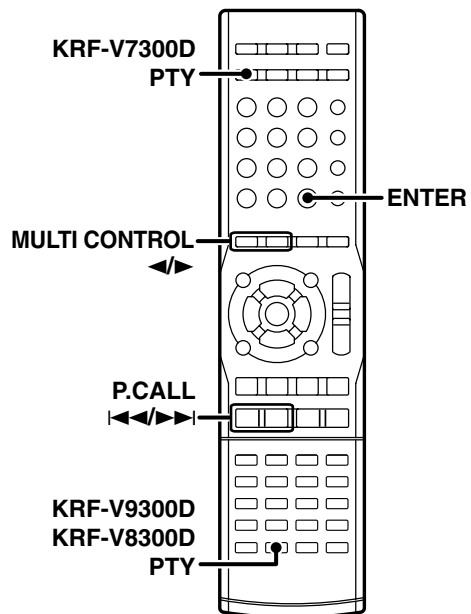

Preparations

- Execute the RDS auto memory procedure.
- Set the broadcast band to FM.
- Tune to an RDS station.

- 1 Press [PTY] to activate the PTY search mode.

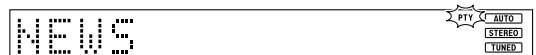

When an RDS broadcast is received, the program type is shown on the display. If no PTY data is available, or if the station is not an RDS station, "None" is displayed.

2 While the "PTY" indicator is lit, use [P.CALL] <◀▶> to select the program type of your choice.

Program type	Display	Program type	Display
Pop Music	"Pop M"	Weather	"Weather"
Rock Music	"Rock M"	Finance	"Finance"
Easy Music	"Easy M"	Children's Program	"Children"
Light Classical Music	"Light M"	Social Affairs	"Social"
Serious Classical Music	"Classics"	Religion	"Religion"
Other Music	"Other M"	Phone In	"Phone In"
News	"News"	Travel	"Travel"
Current Affairs	"Affairs"	Leisure	"Leisure"
Information	"Info"	Jazz Music	"Jazz"
Sport	"Sport"	Country Music	"Country"
Education	"Educate"	National Music	"Nation M"
Drama	"Drama"	Oldies Music	"Oldies"
Culture	"Culture"	Folk Music	"Folk M"
Science	"Science"	Documentary	"Document"
Varied Speech	"Varied"		

3 Press [ENTER] to start searching.

Example: Searching for a Rock Music broadcast.

Display while searching.



Display when a station is received.

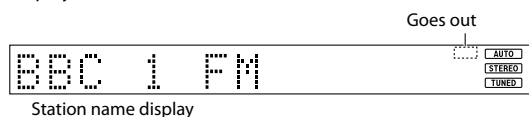

No sound is heard while "PTY" is blinking.

If the desired program type cannot be found, "No Program" is displayed, then after several seconds the display returns to the original display.

To select another program type

Repeat steps 1, 2 and 3.



- [MULTI CONTROL <◀▶>] can also be used to select a station.

Using the DISPLAY key

- Operation available only on the remote control unit.

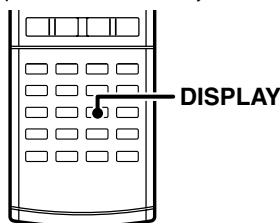

Pressing [DISPLAY] changes the contents of the display.

Each press switches the display mode as follows:

- 1 PS (Program Service) name display
- 2 RT (Radio Text) display
- 3 Frequency display

1 PS (Program Service) name display:

The station name is displayed automatically when an RDS broadcast is received.

If no PS data was sent, "No PS" is displayed.

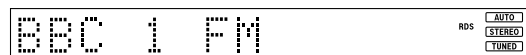

2 RT (Radio Text) display:

Text data accompanying the RDS broadcast scrolls across the display. "No RT" or "RT-----" is displayed if the current RDS station does not provide RT data.



3 Frequency display:

Displays the frequency of the current station.



Recording mode setting in digital audio source recording

- Operation available only on the main unit of this unit.

When recording a multi-channel digital audio source, it is recommended to set up the recording mode properly to convert the digital input into the 2-channel analog output. Usually use the "A-REC" (Auto record) mode. However, some discs often produce sound skipping. The "M-REC" (Manual record) mode should be used with such a disc.

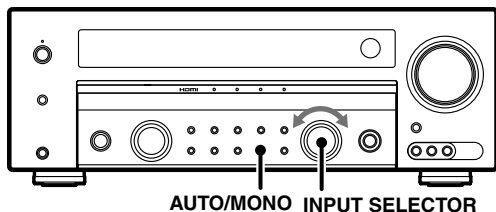

1 Use [INPUT SELECTOR] to select the digital input source you want to record.

The digital input source refers to the source input into the digital input terminals (optical and coaxial) on the rear panel. The input at the CD (ASSIGNABLE) terminal follows the input assignment setup. (See <Input assignment -"Assignment"-> → [39](#).)

2 Set the MD or TAPE recorder to record.

3 Press and hold [AUTO/MONO] for more than 2 seconds to select a recording mode.

Recording mode	Display	Operation
Recording mode off	"RecMode Off"	The digital input record mode is switched off.
Auto record mode	"RecMode Auto"	The digital input signals (DTS, Dolby Digital, or PCM) are identified automatically and converted into stereo signals that are ready for recording.
Manual record mode	"RecMode Manual"	The digital input signal type at the moment this mode is selected is held throughout this mode, and the signal is converted into stereo signals. But once the digital signal is changed to other signal, no signal is output.

When the "A-REC" mode is selected, the digital input signal is converted to stereo signals even if the digital signal is changed.

When the digital mode changes during recording in the "A-REC" mode, the audio input source may be interrupted momentarily.

For "A-REC" mode:

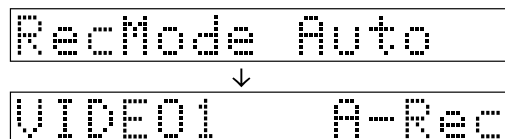

For "M-REC" mode:

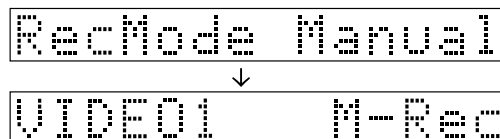

4 Start playback, then start recording.

If the audio reproduction stops in the middle due to change in the input signals, etc., press [AUTO/MONO].



- Recording mode cannot be set when HDMI is enabled. (See <HDMI input setup -"HDMI Input"-> → [40](#).)

Recording audio (analog sources)

1 Use [INPUT SELECTOR] to select the source (other than "MD/TAPE") you want to record.

2 Set the MD or TAPE recorder to record.

3 Start playback, then start recording.

Recording video

1 Use [INPUT SELECTOR] to select the video source (other than "VIDEO1") you want to record.

2 Set the video recorder component connected to VIDEO 1 to record.

Select the recording mode to record a digital input source. See <Recording mode setting in digital audio source recording>.

3 Start playback, then start recording.



- Recording may not be normal for some video software. This is due to the copy guard condition.

Adjusting the sound

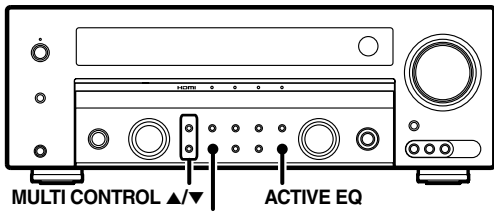

ENTER

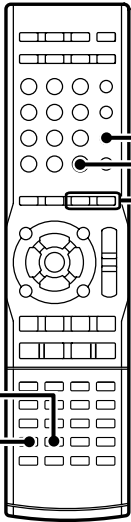

BASS BOOST
ACTIVE EQ

ACTIVE EQ mode

The optimum acoustic field effect can be selected according to the purpose of playback.

Press [ACTIVE EQ].

Each press switches the mode as follows:

Display	Setting
"Active EQ Music"	Effective when listening to music.
"Active EQ Cinema"	Effective when watching a movie.
"Active EQ Game"	Effective when playing a game.
"Active EQ Off"	Active EQ function is off.

ACTIVE EQ indicator lights up.



Adjusting the Tone

● Operation available only on the remote control unit.

The tone level can be adjusted when the input signal is a PCM or analog signal and the listen mode of this unit is set to "Stereo", and also ACTIVE EQ mode is set to "Off".

1 Press [TONE].

2 Select whether or not the tone level is to be adjusted.

Use [MULTI CONTROL ▼/▲] to select "Tone On" or "Tone Off".



Tone On

[ENTER]

Display	Setting
"Tone On"	The tone level can be adjusted. Go to step 3 after setting.
"Tone Off"	The tone level is not adjusted.

3 Adjust the level of "Bass" (low frequencies).

Use [MULTI CONTROL ▼/▲] to adjust the level.



Bass +6

[ENTER]

The level is adjusted from -10 to +10.

4 Adjust the level of "Treble" (high frequencies).

Use [MULTI CONTROL ▼/▲] to adjust the level.



Treble -10

[ENTER]

The level is adjusted from -10 to +10.

Bass Boost

● Operation available only on the remote control unit.

The Bass Boost can be adjusted when the input signal is a PCM or analog signal and the listen mode of this unit is set to "Stereo", and also ACTIVE EQ mode is set to "Off".

Press [BASS BOOST].

Press the key once to select the maximum (+10) low frequency emphasis setting.

TONE will automatically be turned ON.

To cancel

Press [BASS BOOST] again.

Adjustments according to the playing source

The audio can be adjusted as desired according to the source being played.

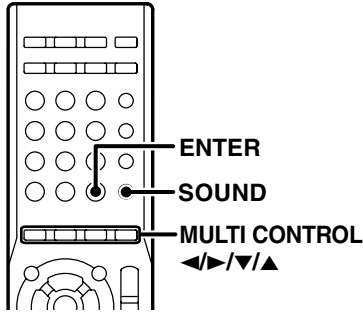

- 1 Press [SOUND] to enter the surround adjustment mode.
- 2 Use [MULTI CONTROL ◀/▶] to select the item to adjust.

Display	Setting item	Range	
"CNTR"	Center speaker level	-10 – +10dB	
"SR"	Surround Right speaker level	-10 – +10dB	
"SBR"	Surround Back Right speaker level	-10 – +10dB	
"SB"	Surround Back speaker level	-10 – +10dB	*1
"SBL"	Surround Back Left speaker level	-10 – +10dB	
"SL"	Surround Left speaker level	-10 – +10dB	
"SUBW"	Subwoofer level	-10 – +10dB	
"INPUT"	Input level	-6, -3, 0	*2
"PANORAMA"	Panorama mode	"On", "Off"	
"Dimension"	Dimension		*3
"Center Width"	Center Width		
"Center Image"	Center Image		*4
"Midnight"	Midnight mode	"Auto", "1", "2", "Off"	*5
"Dual Mono"	Dual mono audio selection	"Main", "Sub", "Main+Sub", "Stereo"	

*1 The adjustment is only temporary for the current input selection. The value will return automatically to the original setup value when the power is turned on/off or when the input selection is changed.

*2 Analog source only

*3 Pro Logic II Music mode and Pro Logic IIx Music mode only

*4 Neo:6 Music mode only

*5 For "Auto": Dolby TrueHD source only

- 3 Use [MULTI CONTROL ▼/▲] to adjust the desired item.

For detailed adjustment method, see the explanation of each item.

To exit the sound adjustment mode

Press [SOUND].

Speaker level adjustment

The output level from the desired speaker channels can be fine adjusted according to the properties of each source. The adjustment is only temporary for the current input selection. The value will return automatically to the original setup value when the power is turned on/off or when the input selection is changed.

- 1 Use [MULTI CONTROL ◀/▶] to select the speaker to adjust ("CNTR", "SR", "SBR", "SB", "SBL", "SL" or "SUBW").



- 2 Use [MULTI CONTROL ▼/▲] to adjust the level.



- 3 Repeat steps 1 and 2 to adjust the level of other speakers.

Input level adjustment

- Analog source only

If the input level of an analog source signal is too high, the CLIP indicator will light to indicate. Adjust the input level.

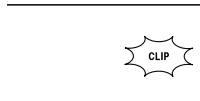

- 1 Use [MULTI CONTROL ◀/▶] to select "INPUT".



- 2 [MULTI CONTROL ▼/▲] to adjust the input level.



Panorama mode

- Pro Logic IIx Music and Pro Logic II Music mode only

The acoustic field of the front channels can be expanded till the field of surround channels, which makes it possible to create sound expansion in the front of the listener.

- 1 Use [MULTI CONTROL ◀/▶] to select "PANORAMA".



PANORAMA Off

- 2 Use [MULTI CONTROL ▼/▲] to select "On" or "Off".

Display	Setting
"PANORAMA On"	PANORAMA mode is on.
"PANORAMA Off"	PANORAMA mode is off.



PANORAMA On

Dimension

- Pro Logic IIx Music and Pro Logic II Music mode only

The center of the acoustic field can be moved toward the front or rear.

- 1 Use [MULTI CONTROL ◀/▶] to select "Dimension".



Dimension

- 2 Press [ENTER].

- 3 Use [MULTI CONTROL ▼/▲] to move the acoustic field to the front or rear.

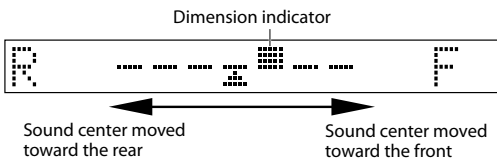

Center width

- Pro Logic IIx Music and Pro Logic II Music mode only

The center channel audio can be distributed to the front left and right speakers to enhance the width of the sound in front of the listener.

- 1 Use [MULTI CONTROL ◀/▶] to select "Center Width".



Center Width

- 2 Press [ENTER].

- 3 Use [MULTI CONTROL ▼/▲] to move the acoustic field to the left or right.

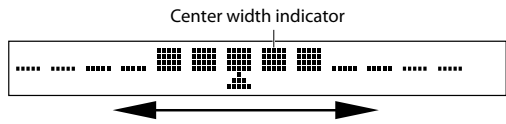

When the indicator extends to the left and right wider, more part of the center channel audio is distributed to the front left and right speakers.



- This setup is not available when the center speaker setup is "Off".

Center image

- DTS Neo:6 Music mode only

The output level of the center speaker can be adjusted.

- 1 Use [MULTI CONTROL ◀/▶] to select "Center Image".



Center Image

- 2 Press [ENTER].

- 3 Use [MULTI CONTROL ▼/▲] to adjust the center speaker output.

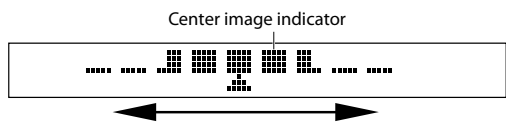

When the indicator extends to the left and right wider, more part of the center channel audio is distributed to the front left and right speakers.



- This setup is not available when the center speaker setup is "Off".

Midnight mode

- Dolby TrueHD, Dolby Digital and DTS mode only

When watching movies at night, you might not be able to raise the volume as loud as normal. Midnight mode compresses the dynamic range of previously specified heavy sound passage of the Dolby TrueHD, Dolby Digital and DTS mode sound track (like scenes with sudden increases in volume) to minimize the difference in volume between the scenes with heavy sound passage and scenes with normal sound passage. This makes it easy to hear all of the sound track, even when listening at low volumes.

- 1 Use [MULTI CONTROL ◀/▶] to select "Midnight".

- 2 Press [ENTER].

- 3 Use [MULTI CONTROL ▼/▲] to select "TrueHD" or "D/D/DTS".

Display	Setting
"TrueHD"	Select it when in Dolby True HD mode.
"D/D/DTS"	Select it when in Dolby Digital or DTS mode.

- 4 Press [ENTER].

- 5 Use [MULTI CONTROL ▼/▲] to select the level.

Display	Setting
"NIGHT Auto"*	Midnight mode auto
"NIGHT 1"	Midnight mode level 1
"NIGHT 2"	Midnight mode level 2
"NIGHT Off"	Midnight mode off

* "NIGHT Auto" can be selected only when "TrueHD" is selected in step 3.



- Some Dolby Digital or DTS software may not be compatible with the Midnight mode.

Switching the main and sub audio

- Dolby Digital and DTS mode only

When playing a 2-language digital broadcast, multiplexed audio broadcast or Dolby Digital multiplexed audio, the main audio and sub audio can be switched.

- 1 Use [MULTI CONTROL ◀/▶] to select "Dual Mono".

- 2 Press [ENTER].

- 3 Use [MULTI CONTROL ▼/▲] to select audio.

Display	Setting
"Main"	Main audio
"Sub"	Sub audio
"Main+Sub"	Main audio + Sub audio
"Stereo"	Main audio on the L channel, Sub audio on the R channel



- The non-monaural multiplexed audio cannot be switched with this unit. Try switching on the source component.

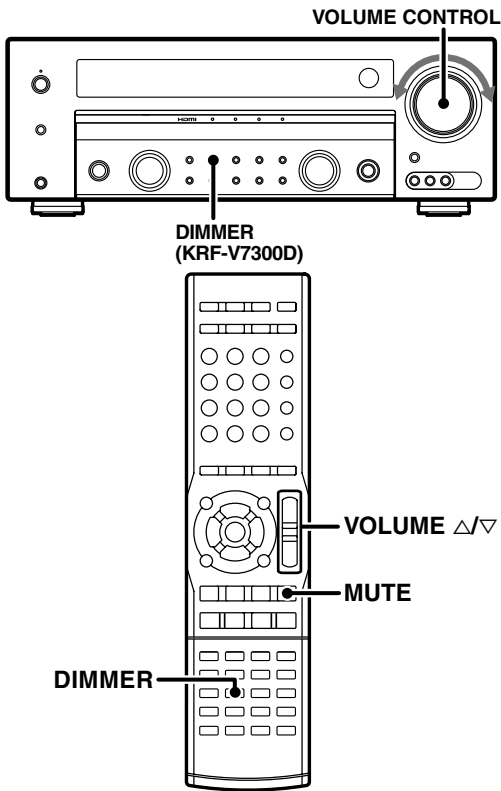

Listening with headphones

1 Connect headphones to the [PHONES] jack.

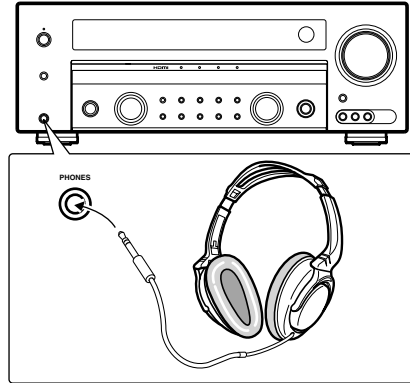

2 Adjust volume.



- The speaker system will be turned off as the headphones are connected. (No sound is output from the speakers connected to this unit.)

Muting the sound

- Operation available only on the remote control unit.

Press [MUTE].

"MUTE" indicator blinks.



To cancel

Press [MUTE] again so that the "MUTE" indicator goes off.

MUTE can also be deactivated by adjusting volume.

Display dimmer adjustment

- KRF-V9300D and KRF-V8300D:

Operation available only on the remote control unit.

The dimmer function lets you select the brightness of the display and indicators of this unit. You might find this useful if you darken your room to watch movies or listen to music.

Press [DIMMER].

The brightness of the display changes among the three available settings. Select the brightness level you find most pleasing.

- ① Slightly dark
- ② Dark
- ③ Normal



- The brightness of the LED indicators changes in 2 levels.

Remote control operations for Kenwood DVD players

The remote control of this unit can control Kenwood DVD players directly without using the remote control supplied with the DVD player.

Compatible DVD player models

DV-4900, DV-4070B, DV-2070, DV-203, DVF-9010, DVF-K7010, DVF-5010, DVF-R9030, DVF-R7030, DVF-3530, DV-402, DV-5900, DV-5700, DVF-R9050, DVF-J6050, DV-505, DV-503, DV-502, DVF-3550, DVF-3050, DVF-R4050, DVF-605, DV-6050, DVF-R5060, DVF-3060, DVF-3060K, DV-705, DVF-R5070, DVF-3070, DVF-3080, DVF-N7080, DVF-8100, DVF-3200, DVF-3250, DVF-3300, DVF-3400, DVF-5400, DVF-3500 and DVF-5500.

How to operate the DVD player with the remote control

1 Press [DVD] to turn the DVD player on.

2 Press [DVD] to operate the functions of the DVD player.

Pressing [DVD] allows you to control the connected Kenwood DVD player with this remote control unit.

3 Press each key for DVD player operation. Refer to the operation manual of the DVD players for the detailed operating instructions.

(To return to the receiver operation mode, press other Input source key.)

DVD player operation keys

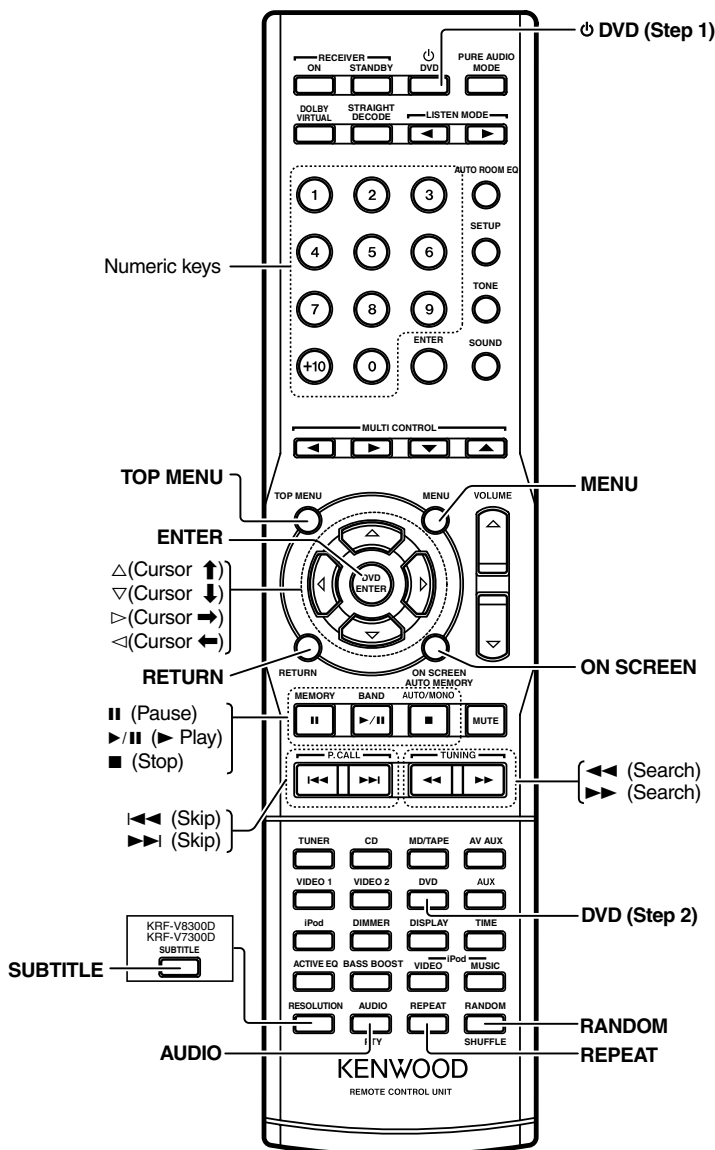

Convenient functions

Troubleshooting

Amplifier

Symptom	Cause	Remedy
No sound from the speakers.	The speaker cords are disconnected.	Connect it properly referring to <Connecting speakers>. → 26
	VOLUME is set to the minimum position.	Adjust the volume to a proper level.
	MUTE is ON.	Turn OFF the MUTE. → 65
	The SPEAKERS switches are set to OFF.	Set the SPEAKERS switch to ON. → 44
	The headphones are connected.	Disconnect the headphones.
	The input source selection is incorrect.	Select the input source you want to play.
	The HDMI setup is disabled.	Confirm the HDMI input by referring to <HDMI input setup – "HDMI Input" –> and HDMI audio output by referring to <Audio Out>. → 40 → 41
	The input mode is not set properly.	Select the optimum input mode by referring to <Selecting the input mode>. → 44
The standby indicator blinks and sound is not output.	Audio signal may not be output depending on the connecting method and connected components.	Refer to the instruction manuals that come with the connected components.
	Speaker cords are short-circuited.	Turn the power off, eliminate the short-circuiting, then turn on the power again. If the standby indicator still blinks after eliminating the short-circuiting, there may be an internal defect. Switch it off, unplug the power cord and call for service.
Sound is not output from one of the speakers.	The speaker cord is disconnected.	Connect it properly referring to <Connecting speakers>. → 26
	The speaker is not set up correctly.	Set it up properly referring to <Speaker setup>. After setting, confirm that the test tone is output. → 31 → 32 → 36
	Some speakers do not output audio depending on the listen mode.	
Sound is not output from the surround speakers and/or the center speaker, or their sound is very soft.	The surround speaker cords and/or the center speaker cord is disconnected.	Connect it properly referring to <Connecting speakers>. → 26
The audio cannot be played in the desired signal format (Dolby Digital or DTS).	Digital connection is necessary to play the Dolby Digital, or DTS input signal in the input signal format.	Confirm that the input signal is connected to the digital input or HDMI input terminal by referring to <Connections>. → 14 → 29
	The player component is not set for digital output.	Confirm the audio output setup of the player component by referring to its instruction manual.
When playing a Dolby Digital or DTS source, the sound is cut off soon after it starts.	There are many possible causes for this problem, depending on the player used.	Set the input mode to "Digital Manual" ("Signal Manual") before starting playback of the Dolby Digital or DTS source. → 44
No sound is produced during playback from a DVD player.	The input mode is set to digital manual.	Press the [INPUT MODE] key to select to "Full Auto" ("Signal Auto"). → 44
A video source cannot be recorded normally.	The software is copy-guarded.	Copy-guarded video software cannot be recorded.
The audio of a digital broadcast cannot be switched.	The audio of certain broadcasts cannot be switched with this unit.	Switch the audio on the digital tuner.
A message such as "Ex: XXX" or "Cx: XXX" is displayed.	A certain trouble is detected during the measurement for Auto Setup.	Refer to <Error messages> and <Confirmation messages>. → 34 → 35

Troubleshooting

Symptom	Cause	Remedy
The video is not output or is disturbed.	The video component is not connected properly.	Connect it properly by referring to <Connections>. → 14 → 29 If the video component is connected to this unit through HDMI connection, the digital video signal input from the HDMI input terminals is output only at the HDMI monitor output terminal.
	Video signal may not be output depending on the connecting method and connected components.	Refer to the instruction manuals that come with the connected components.
	The input of the TV monitor is not set properly.	Confirm the input setup of the TV monitor.
	A non NTSC/PAL video signal is input.	Set the video setup of the video player component to NTSC/PAL. Refer to the instruction manual of the video player component.
	The HDMI video input is set to "Off" in the HDMI setup.	Perform the HDMI setup again by referring to <HDMI input setup – "HDMI Input"–>. → 40
	PURE AUDIO MODE is set to "ON".	If PURE AUDIO MODE is set to "ON", the video circuitry is switched off and only the input HDMI video can be output. Set PURE AUDIO MODE to "OFF". → 46
Display is turned off.	PURE AUDIO MODE is on.	While the PURE AUDIO MODE is on, the display is turned off. Turn off the PURE AUDIO MODE. → 46

Tuner

Symptom	Cause	Remedy
Radio stations cannot be received.	No antenna is connected.	Connect an antenna. → 28
	The broadcast band is not set properly.	Set the broadcast band properly. → 56
	The frequency of the desired station is not tuned.	Tune in the frequency of the desired station. → 56
Interference	Noise due to ignition of an automobile.	Install the outdoor antenna away from the road.
	Noise due to interference from an electric appliance.	Turn off the power to the appliance.
	Noise due to a nearby TV set.	Install the unit farther away from the TV.

Remote control unit

Symptom	Cause	Remedy
Remote control operation is not possible.	The remote control is not set to the source operation mode you wish to control.	Press the appropriate Input Source key to select the source you wish to control.
	The remote control has not been changed to the operation mode for the Kenwood DVD player you wish to control.	Press the [DVD] key to activate the operation mode for the component you want to control before operation. → 66
	Batteries are exhausted.	Replace with new batteries. → 12
	The remote control unit is too far away from the main system, controlling angle is too large, or there is an obstacle between this unit and the remote.	Operate the remote control unit within the controllable range. → 13
	There is an obstacle between this unit and the remote control unit.	Remove the obstacle.
	Operation is attempted while recording mode is set to on.	Some functions cannot control while the recording mode is set to on. When not recording, set the recording mode to off. → 60

Resetting the Microcomputer

If the unit is completely inoperable, the display is not normal or a problem cannot be solved even after checking the list in <Troubleshooting>, it is required to reset the microcomputer in the unit.

While holding down [⏻] key on the unit, unplug the power cord and plug it back in.

- Please note that resetting the microcomputer will clear the contents of the memory and return the unit to the state it was in when it left the factory.

Dolby Digital

Digital multi-channel audio standard developed by Dolby Laboratories. It supports transmission and recording of high-quality digital audio signals from monaural up to 5.1 channels using an amount of data that is a fraction of the PCM audio format. The main features of Dolby Digital include:

- Downmixing optimized for monaural, stereo and Pro Logic configurations as well as for playback of 6.1-channel audio.
- Transfer of information related to the dynamic range and the conversation level adjustment.
- Wide range of operating bit rates.

Dolby Digital EX/Dolby EX

These extensions of Dolby Digital add the surround back channel to the Dolby Digital channels to deliver a surround effect with enhanced presence and listener envelopment.

Dolby Pro Logic II

This is a matrix decoding technology developed by Dolby Laboratories. It generates 5-channel surround audio with rich feeling of presence from any stereo source, delivering an excellent multidimensional sound field effect even from an ordinary stereo music content including CD music. It offers three modes including the Movie mode optimized for movie playback, the Music mode for music playback and the Game mode for game play.

Dolby Pro Logic IIx

Matrix decoding technology developed by improving Dolby Pro Logic II. It accepts any stereo or 5.1-channel audio input and generates 7.1-channel surround audio with a more natural, smoother surround sound field. It also offers three modes optimized for each source content, including the Movie mode for movie playback, the Music mode for music playback and the Game mode for game play.

Dolby Digital Plus

This is an audio technology developed based on Dolby Digital by improving both the sound quality and functions. It delivers multi-channel surround audio with completely discrete channels. The compatible bit rates have been expanded to between 32 kbps and 6 Mbps from between 96 and 640 kbps with Dolby Digital.

The excellent coding efficiency makes this technology capable of delivering quality audio in max. 7.1 channels without affecting the bit rates assigned for the video and other services. Compatibility with existing home theater systems incorporating the Dolby Digital technology is also secured.

Dolby True HD

This loss-less (reversible) audio technology has been developed by Dolby Laboratories and reproduces high-quality studio-mastered audio data perfectly with bit-order accuracy. It is compatible with up to 7.1 channels when the sampling frequency is 95 kHz and up to 5.1 channels when the sampling frequency is 192 kHz.

Dolby Headphone

This stereo audio technology has been developed by Dolby Laboratories and Lake DSP (presently Dolby Australia) and features reproduction of surround audio through stereo headphones.

Dolby Virtual Speaker

This is a speaker virtual technology that can generate an ideal 5.1-channel home theater environment using only a pair of speakers.

DTS Digital Surround

Digital surround format developed by DTS Corporation. It features low compression rate and high sound quality, and is capable of reproducing max. 5.1 channels.

DTS-ES

This is a 6.1-channel audio technology developed by adding the surround back channel to DTS Digital Surround.

The signal of this format can also be played on existing DTS 5.1-channel components. DTS-ES consists of two types, which are DTS ES Matrix and DTS-ES Discrete 6.1.

DTS-ES Matrix

With this format, the audio for the surround back channel added to the DTS 5.1-channel audio is allocated to the two surround channels during recording. When the signal is decoded, the audio for the surround back channel is restored from the surround channels to deliver the 6.1-channel audio.

DTS-ES Discrete

With this format, the audio for the surround back channel added to the DTS 5.1-channel audio is recorded in an independent channel.

DTS Neo:6

This is a matrix decoding technology developed by DTS Corporation, capable of delivering max. 6.1 channels from any 2-channel source. It includes two modes, including the DTS Neo 6 CINEMA mode optimized for movie playback and the DTS Neo 6 MUSIC mode optimized for music playback.

DTS 96/24

5.1-channel digital audio format developed as an evolution of the DTS 5.1-channel format. It enables high-quality playback with 96 kHz sampling frequency and 24-bit quantization (the signal of this format can also be reproduced on existing DTS 5.1-channel player components).

DTS–HD Master Audio

This loss-less (reversible) audio technology has been developed by DTS Corporation and reproduces audio in the same high quality as the studio-mastered audio data. With 96 kHz sampling frequency and 24-bit quantization, it is compatible with max. 7.1 channels. This technology can be played with any of seven speaker layout patterns, making the content producer capable of delivering the intended sound effects in a variety of audio reproduction environments of users.

DTS-HD High Resolution Audio

This is an extension of the previous DTS audio format and can record 7.1-channel audio with 96 kHz sampling frequency and 24 quantization bits. The multi-channel sound recorded with DTS-HD High Resolution Audio can reproduce details more clearly and realistically than the audio of DVD-Video.

This technology can also be played with any of seven speaker layout patterns, making the content producer capable of delivering the intended sound effects in a variety of audio reproduction environments of users.

DTS-HD Low Bit Rate

One of the DTS-HD audio formats. It is the low bit rate for use in communications including the Internet communications.

HDMI

HDMI (High-Definition Multimedia Interface) is a standard developed based on DVI (Digital Visual Interface) and features the capability of transferring both non-compressed digital video and multi-channel digital audio through a single cable.

This unit is compatible with the HDMI optional functions listed below.

- Deep Color

Video signals with a larger number of bits per color component than ordinary 8 bits, such as the 10-bit and 12-bit signals can be transferred to achieve richer expression of gradations.

- x.v.Color

A larger variety of colors, or about 180% more colors than the number of colors of sRGB color space, can be reproduced.

- Lip Sync

The video and audio are synchronized in the monitor by detecting the delay of monitored video automatically.

DVI

DVI (Digital Visual Interface) is the standard for connection between PC and display.

HDCP

HDCP (High-bandwidth Digital Contents Protection) is copyright protection technology for prevention of illegal duplication of video contents. It is used in encryption of digital interfaces such as DVI and HDMI.

Specifications

AUDIO section

Rated output power during STEREO operation (63 Hz – 20 kHz, 0.7% T.H.D., at 6 Ω)	100 W + 100 W
Effective output power during STEREO operation RMS (1 kHz, 10% T.H.D., at 6 Ω)	130 W + 130 W
Effective power output during SURROUND operation	
FRONT	
(1 kHz, 0.7% T.H.D. at 6 Ω one channel driven)	100 W + 100 W
(1 kHz, 10% T.H.D. at 6 Ω one channel driven)	130 W + 130 W
CENTER	
(1 kHz, 0.7% T.H.D. at 6 Ω one channel driven)	100 W
(1 kHz, 10% T.H.D. at 6 Ω one channel driven)	130 W
SURROUND	
(1 kHz, 0.7% T.H.D. at 6 Ω one channel driven)	100 W + 100 W
(1 kHz, 10% T.H.D. at 6 Ω one channel driven)	130 W + 130 W
SURROUND BACK	
(1 kHz, 0.7% T.H.D. at 6 Ω one channel driven)	100 W + 100 W
(1 kHz, 10% T.H.D. at 6 Ω one channel driven)	130 W + 130 W
Total harmonic distortion	
.....	0.009% (1 kHz, 50 W, 6 Ω)
Frequency response (IHF'66)	
CD	10 Hz – 100 kHz, +0 dB – -3.0 dB
Signal to noise ratio (IHF'66)	
CD	105 dB
Input sensitivity / impedance	
CD, AUX, MD/TAPE, VIDEO 1, VIDEO 2	550 mV / 25 kΩ
AV AUX	550 mV / 25 kΩ
DVD/6CH INPUT	550 mV / 25 kΩ
Output level / impedance	
REC OUT (MD/TAPE, VIDEO 1)	500 mV / 1 kΩ
PRE OUT (SUBWOOFER)	1.3 V / 2.2 kΩ
Tone control	
BASS	±9 dB (at 100 Hz)
TREBLE	±9 dB (at 10 kHz)

DIGITAL AUDIO section

Input terminal	
Optical	CD, VIDEO 2
Coaxial	DVD

VIDEO section

Video format (Video Conversion)	
.....	PAL / NTSC (KRF-V9300D/KRF-V8300D only)
VIDEO input sensitivity / impedance (DVD, VIDEO 1, VIDEO 2, AV AUX)	
Composite	1 Vp-p / 75 Ω
VIDEO output level / impedance (VIDEO 1, MONITOR)	
Composite	1 Vp-p / 75 Ω
S-VIDEO input sensitivity / impedance (DVD, VIDEO 2)	
Y-signal	1 Vp-p / 75 Ω
C-signal	0.286 Vp-p / 75 Ω
S-VIDEO output level / impedance (MONITOR)	
Y-signal	1 Vp-p / 75 Ω
C-signal	0.286 Vp-p / 75 Ω
COMPONENT VIDEO input sensitivity / impedance (DVD, VIDEO 1, VIDEO 2)	
Y-signal	1 Vp-p / 75 Ω
CB/ CR-signal	0.7 Vp-p / 75 Ω
COMPONENT VIDEO output level / impedance (MONITOR)	
Y-signal	1 Vp-p / 75 Ω
CB/ CR-signal	0.7 Vp-p / 75 Ω

HDMI section

HDMI input terminal	DVD, VIDEO 2
HDMI output terminal	MONITOR

FM tuner section

Tuning frequency range	87.5 MHz – 108.0 MHz
------------------------	----------------------

AM tuner section

Tuning frequency range	531 kHz – 1,602 kHz
------------------------	---------------------

iPod section

Maxmum current drain	500 mA
----------------------	--------

General

Power consumption	
KRF-V9300D	275 W
KRF-V8300D/KRF-V7300D	255 W
Standby power consumption (HDMI Link :Off)	less than 0.4 W
Dimensions (KRF-V9300D)	
.....	W: 440 mm (17-5/16")
.....	H: 166 mm (6-9/16")
.....	D: 394 mm (15-1/2")
Dimensions (KRF-V8300D/KRF-V7300D)	
.....	W: 440 mm (17-5/16")
.....	H: 159 mm (6-1/4")
.....	D: 394 mm (15-1/2")
Weight (net)	
KRF-V9300D	11.0 kg (24.3 lb)
KRF-V8300D/KRF-V7300D	10.9 kg (24.0 lb)



1. Kenwood follows a policy of continuous advancements in development. For this reason specifications may be changed without notice.
2. The full performance may not be exhibited in an extremely cold location (under a water-freezing temperature).

KENWOOD

For your records

Record the serial number, found on the back of the unit, in the spaces designated on the warranty card, and in the space provided below. Refer to the model and serial numbers whenever you call upon your dealer for information or service on this product.

Model _____ Serial Number _____